

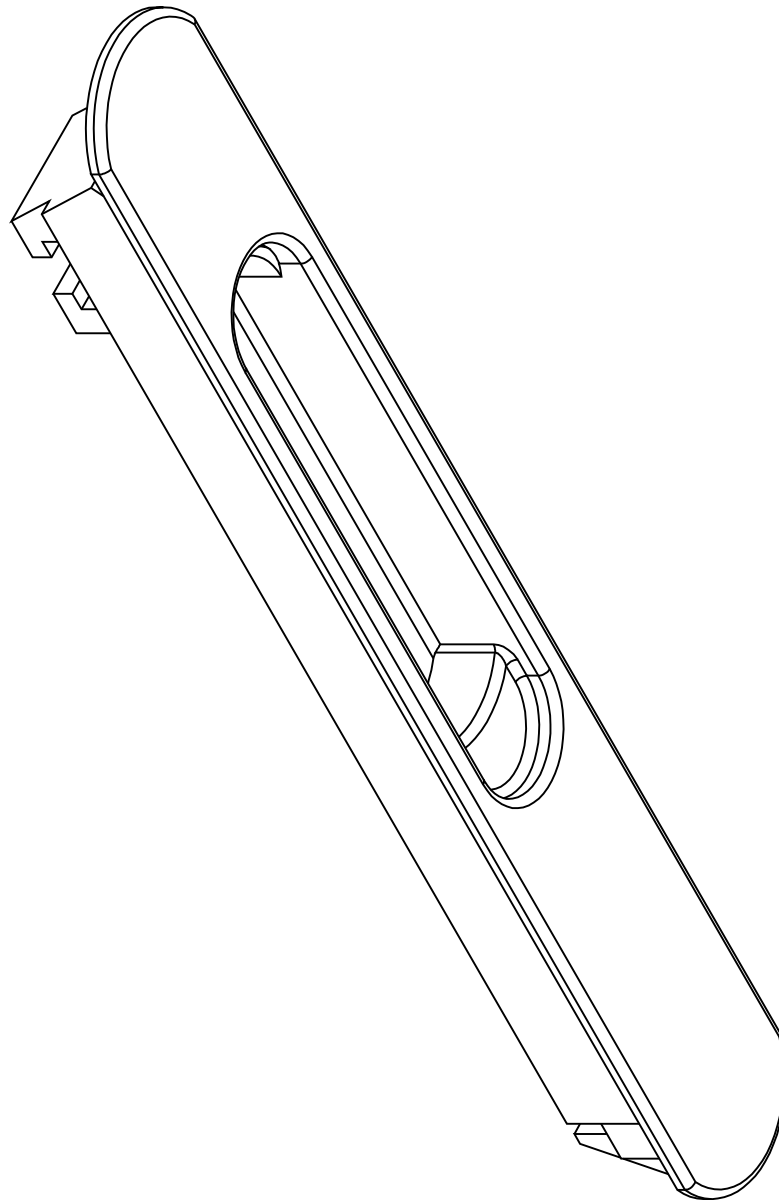

ÍNDICE

H54 ALUMINIO -----	1-11
H56 PROIN + CERRADURA / AUTOMÁTICO -----	12-20
H56 PROIN - ZAMAK + LLAVE - CLIPAR -----	21-28
H56 PROIN para clipar. -----	29-36
H56 PROIN -----	37-44
H56 CH - CLIPAR -----	45-55
H56 - 1615 PROIN -----	56-65
H56 DOPPIO PROIN -----	66-74
H56 DOPPIO - H101 -----	75-84
H56 ESTILO PROIN -----	85-93
H56 ESTILO H101 -----	94-98
H101-1501 PROIN -----	99-103



H54 PROIN aluminio
Escala 1:1

HA62 CORREDIZA

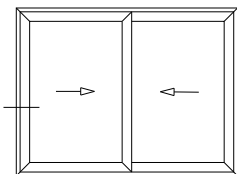

H54 PROIN ALUMINIO

Lateral Corrediza 2 hojas
Marco a 90° / Hoja a 45°

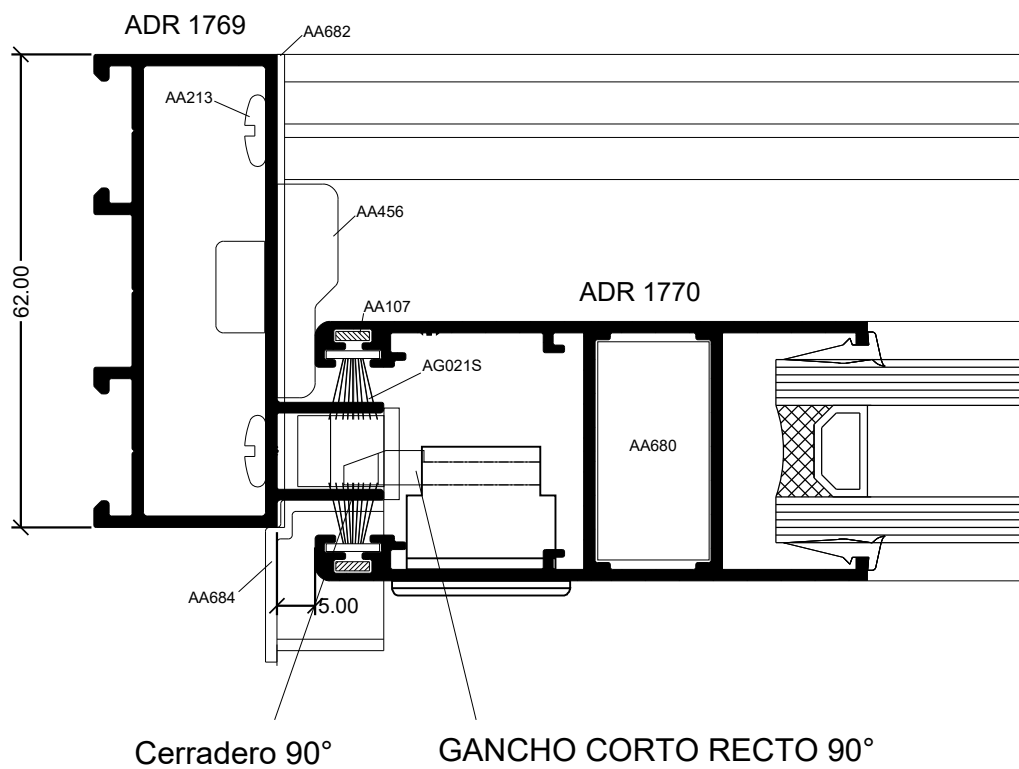

HA62 CORREDIZA

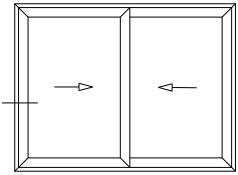

H54 PROIN ALUMINIO

Lateral Corrediza 2 hojas
Marco a 45° / Hoja a 45°

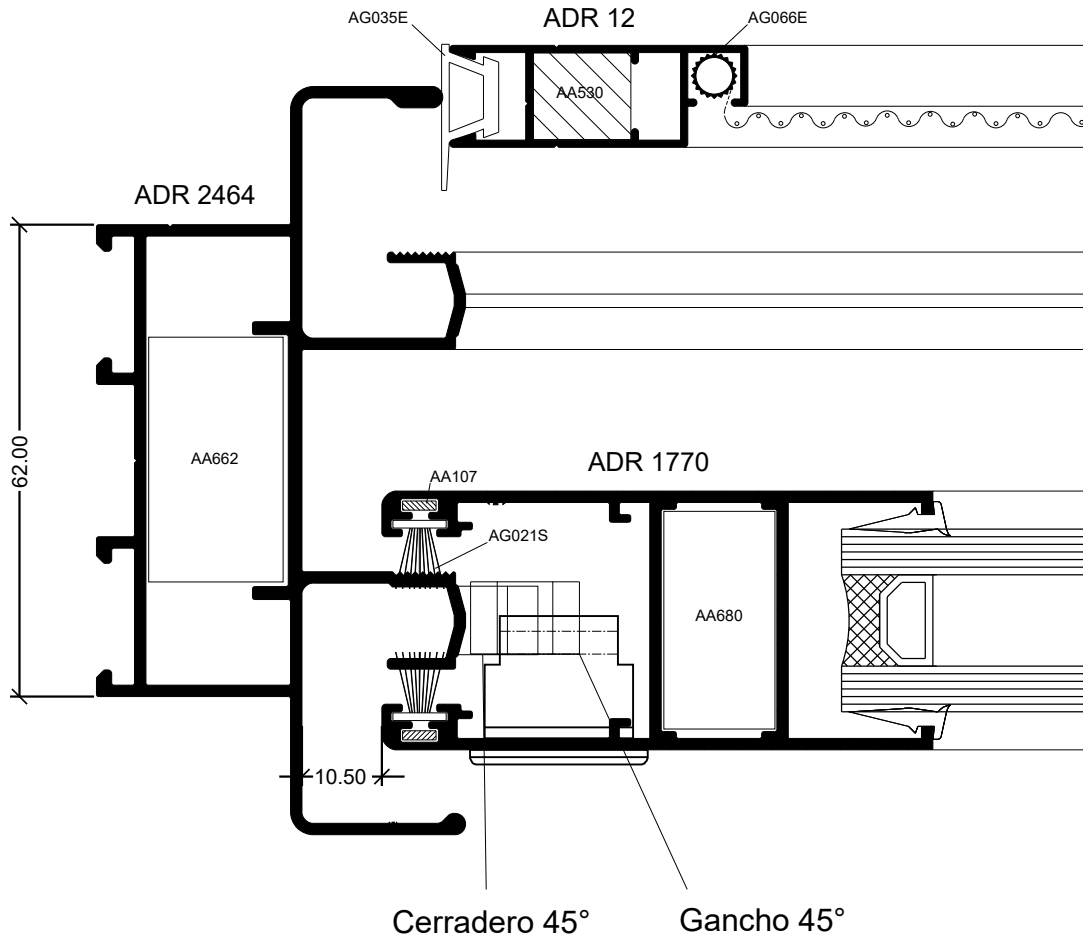

HA62 CORREDIZA

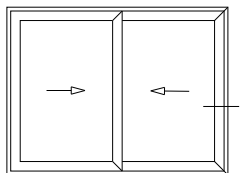

H54 PROIN ALUMINIO

Lateral Corrediza 2 hojas
Marco a 45° / Hoja a 90°

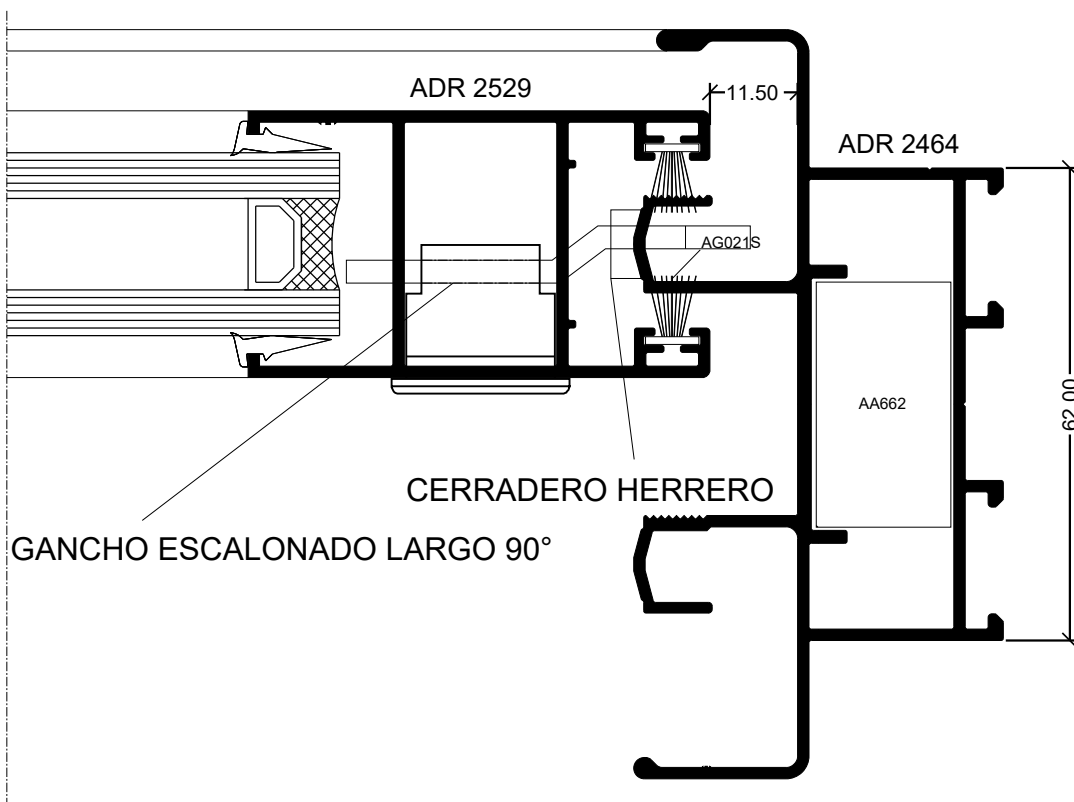

HA62 CORREDIZA

PROiN

La Aldaba

Hydro

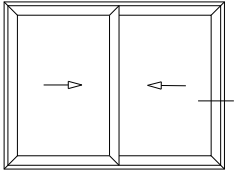

H54 PROIN ALUMINIO

Lateral Corrediza 2 hojas
Marco a 90° / Hoja a 90°

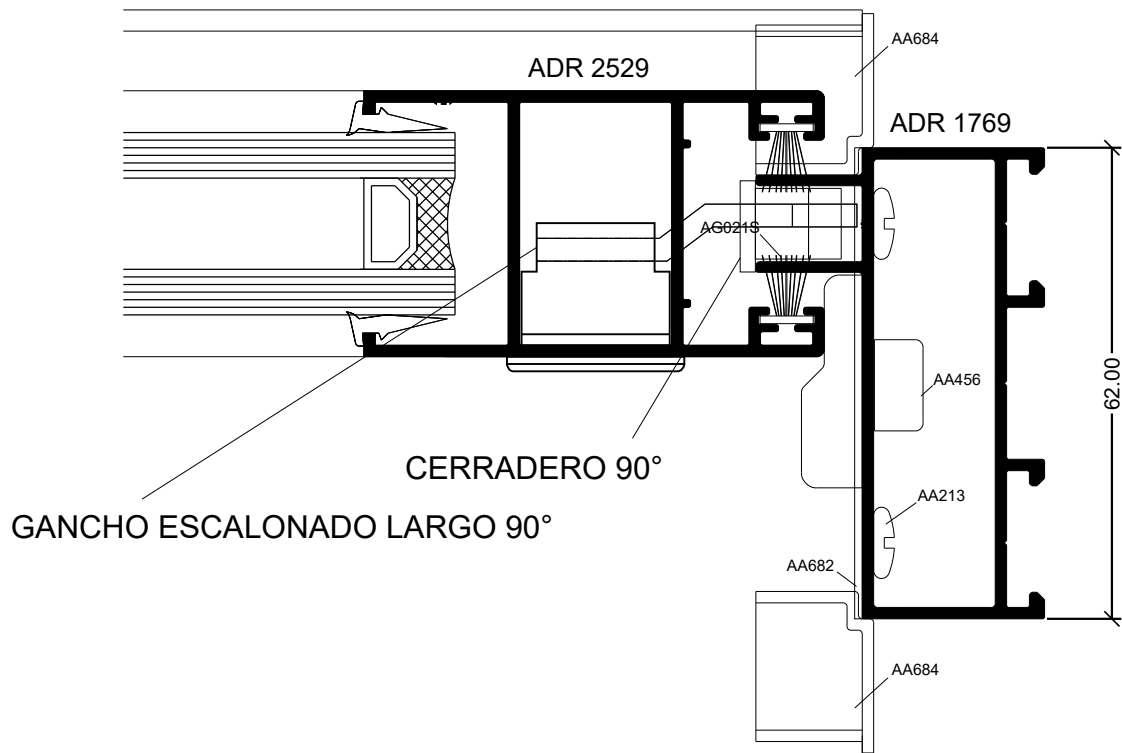

HA62 CORREDIZA

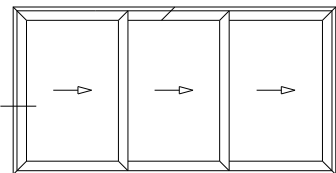

H54 PROIN ALUMINIO

Lateral Corrediza 2 hojas
Marco a 90° / Hoja a 45°

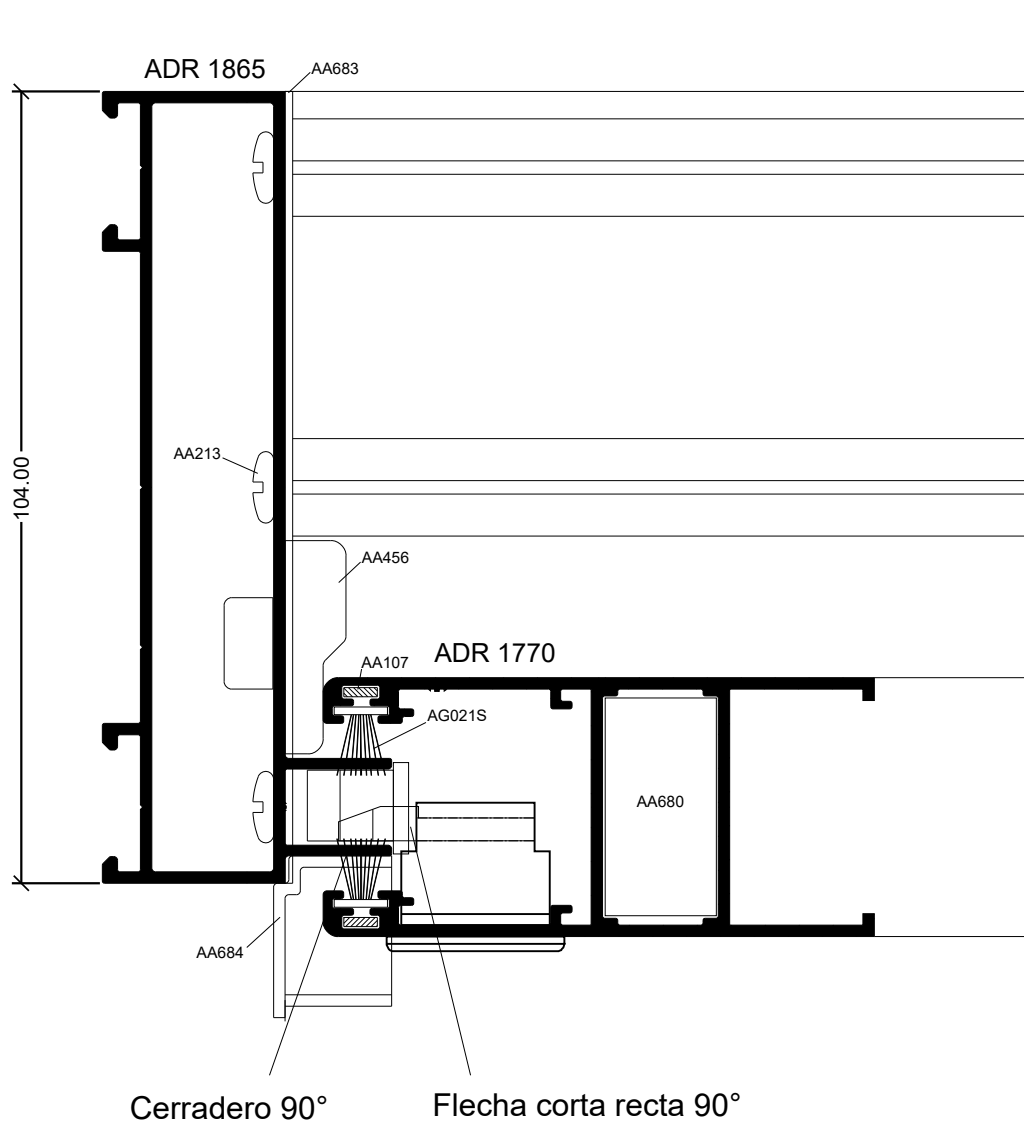

NÓRDICAL

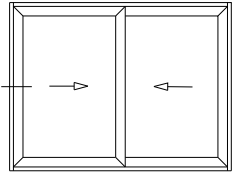

PROiN

La Aldaba

Hydro

H54 PROIN ALUMINIO

Lateral Corrediza 2 hojas
Marco a 90° / Hoja a 45°

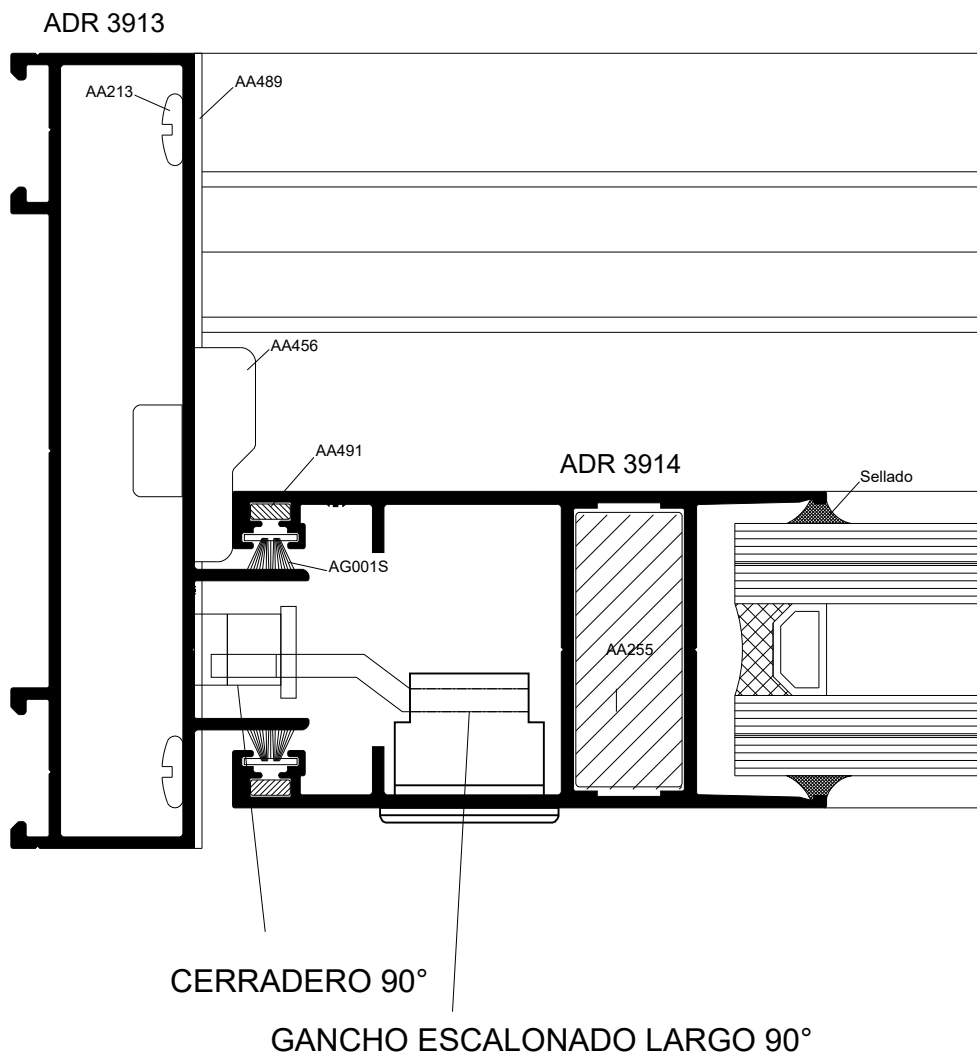

ORBITAL

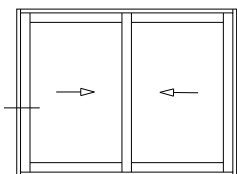

PROiN



La Aldaba



Hydro

H54 PROIN ALUMINIO

Lateral Corrediza 2 hojas + mosquitero

Marco a 90° / Hoja a 90°

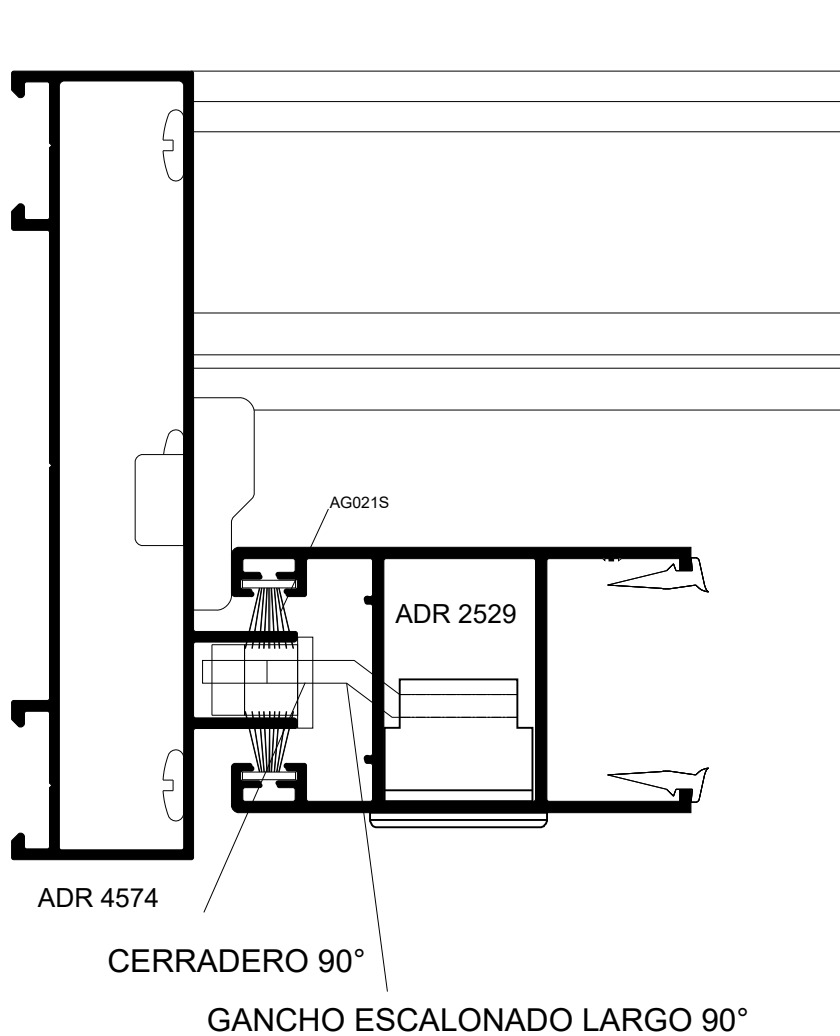

ORBITAL

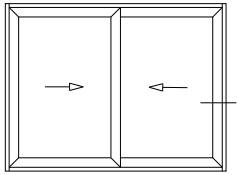

Lateral Corrediza 2 hojas + mosquitero

Marco a 90° / Hoja a 45°

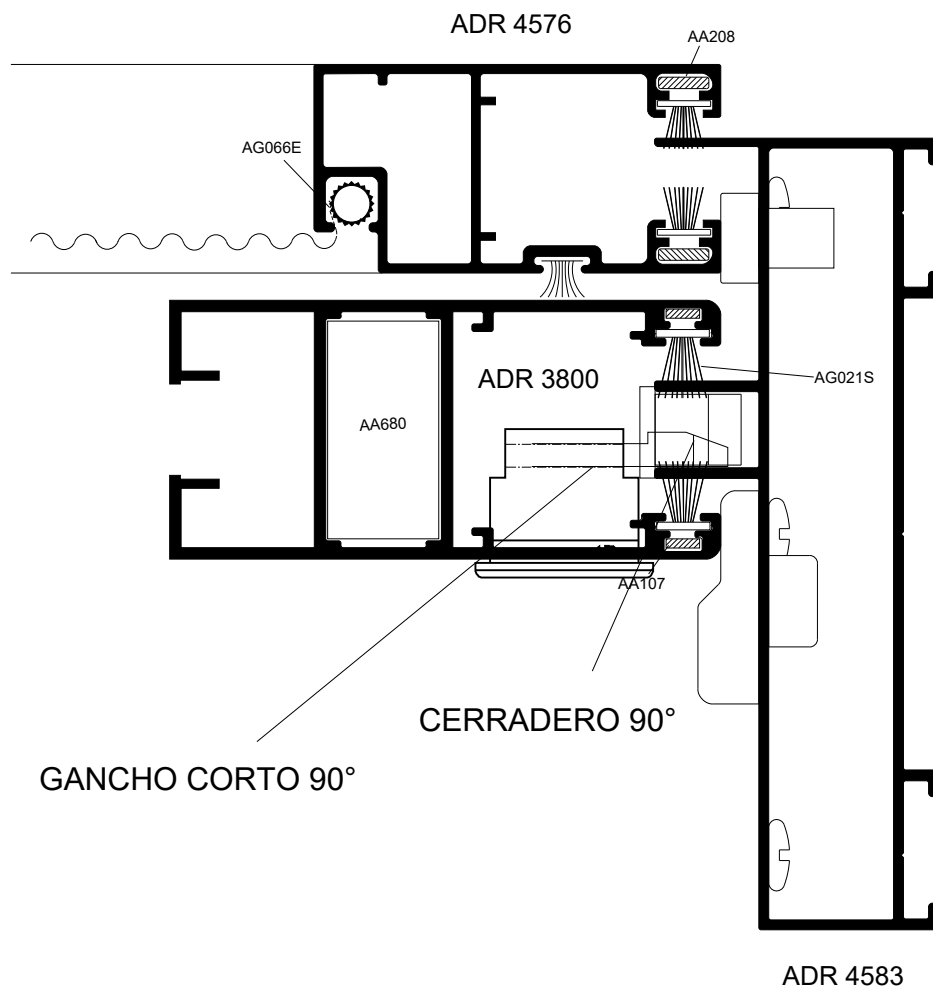

ORBITAL

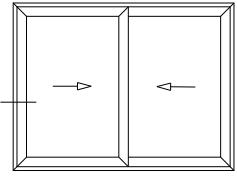

PROiN



La Aldaba®



Hydro

H54 PROIN ALUMINIO

Lateral Corrediza 2 hojas + mosquitero

Marco a 45° / Hoja 45°

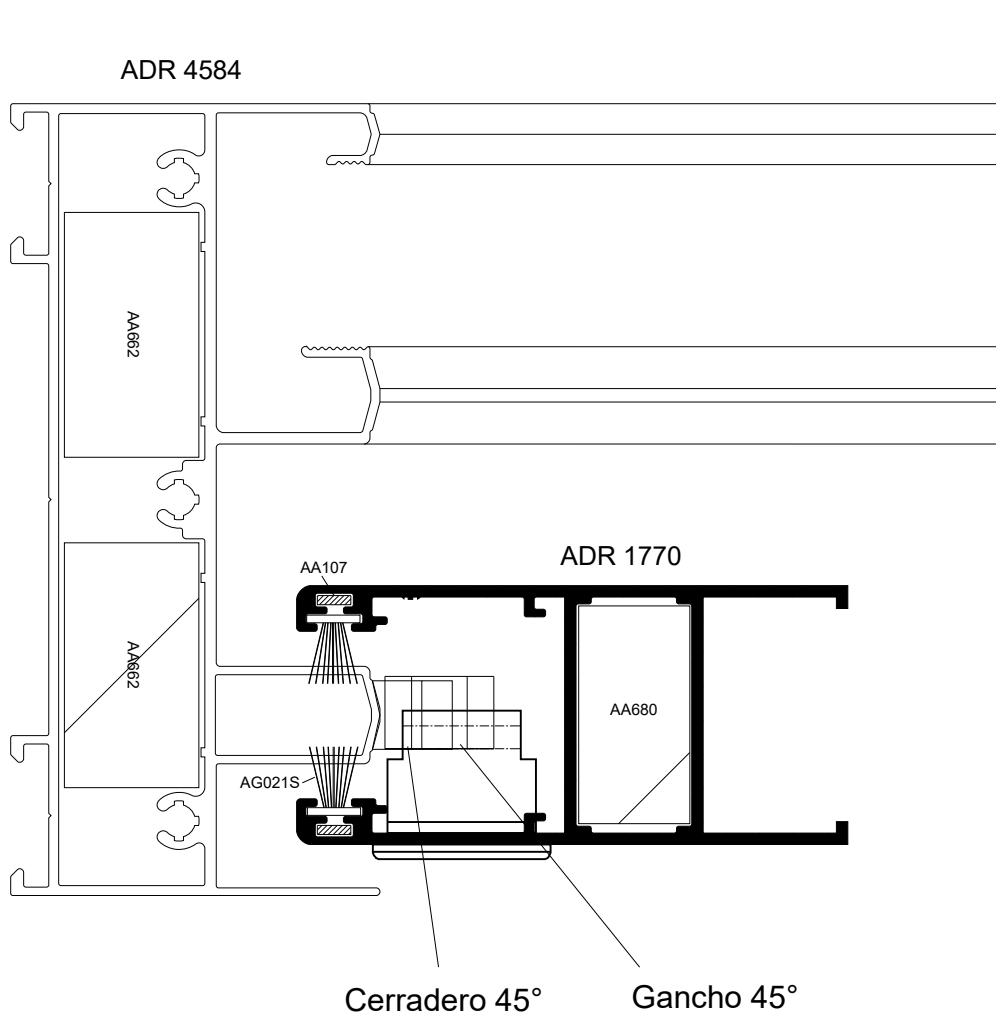

2200

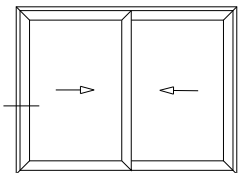

PROiN



La Aldaba



Hydro

H54 PROIN ALUMINIO

Lateral Corrediza 2 hojas + mosquitero

Marco a 90° / Hoja 90°

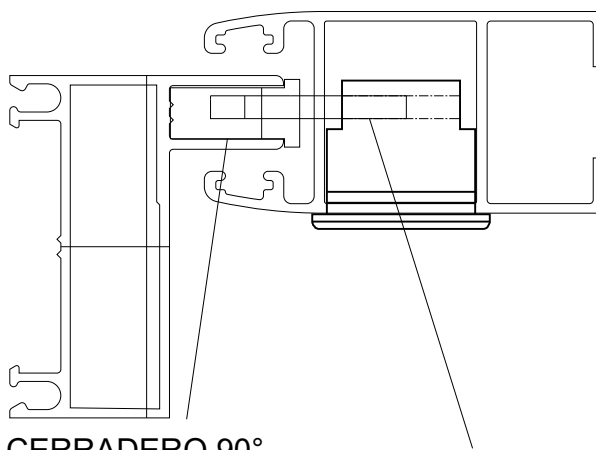

CERRADERO 90°

GANCHO CORTO 90°

ADR 2203
Parante lateral V.S.
0.650 Kg/m

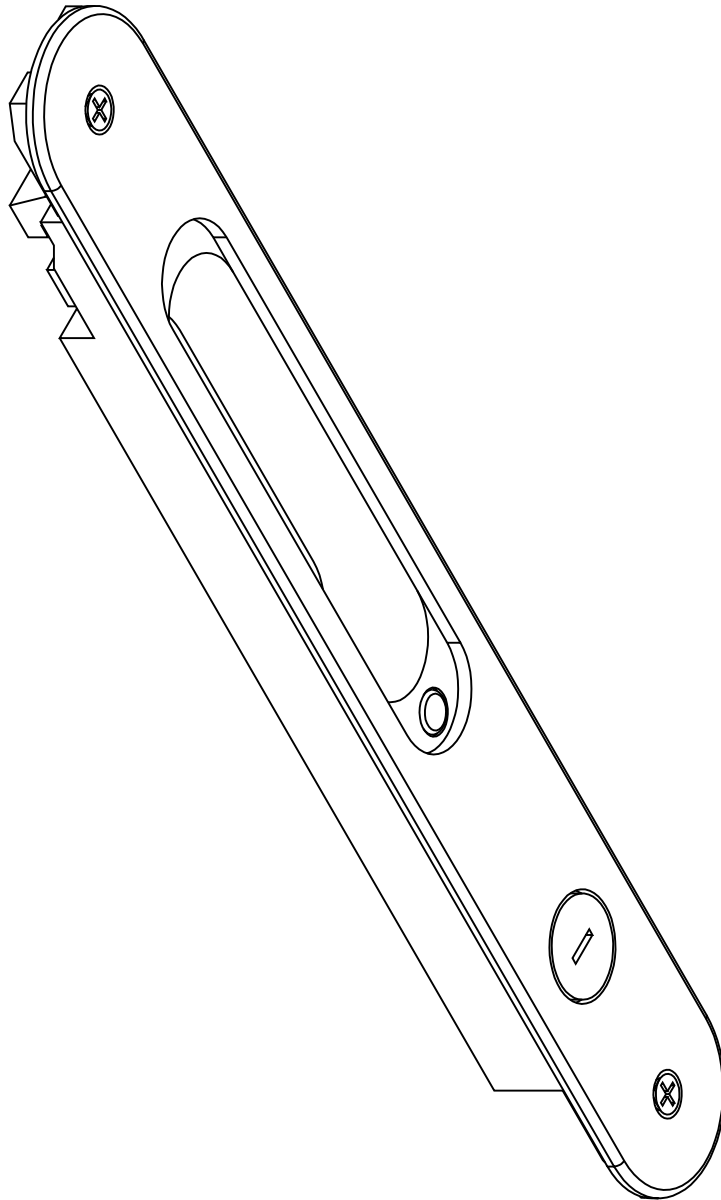

H56 + Cerradura - automático
Escala 1:1

HA62 CORREDIZA

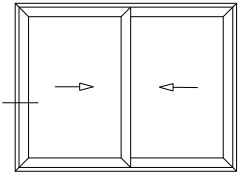

H56 + Cerradura - automático

Lateral Corrediza 2 hojas
Marco a 45° / Hoja a 45°

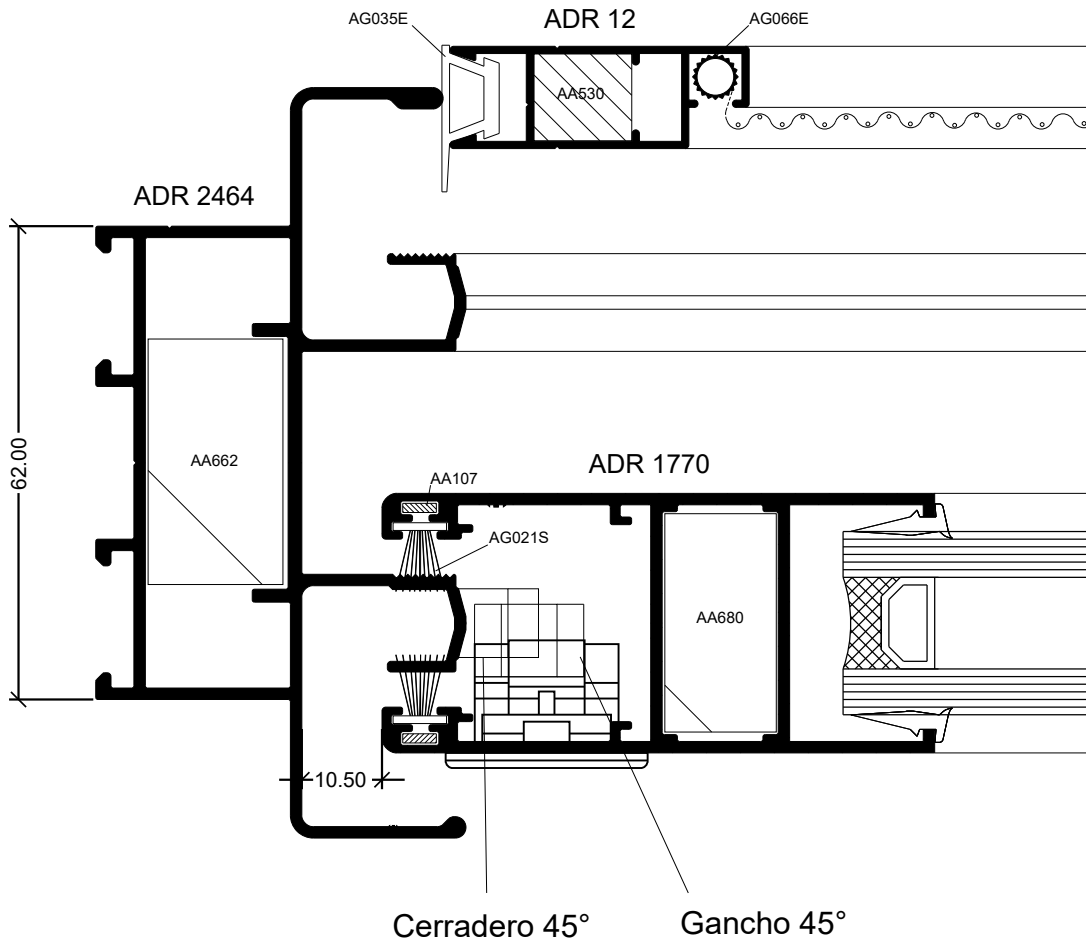

HA62 CORREDIZA

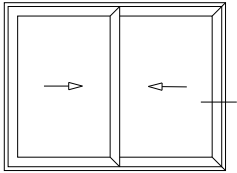

H56 + Cerradura - automático

Lateral Corrediza 2 hojas
Marco a 45° / Hoja a 90°

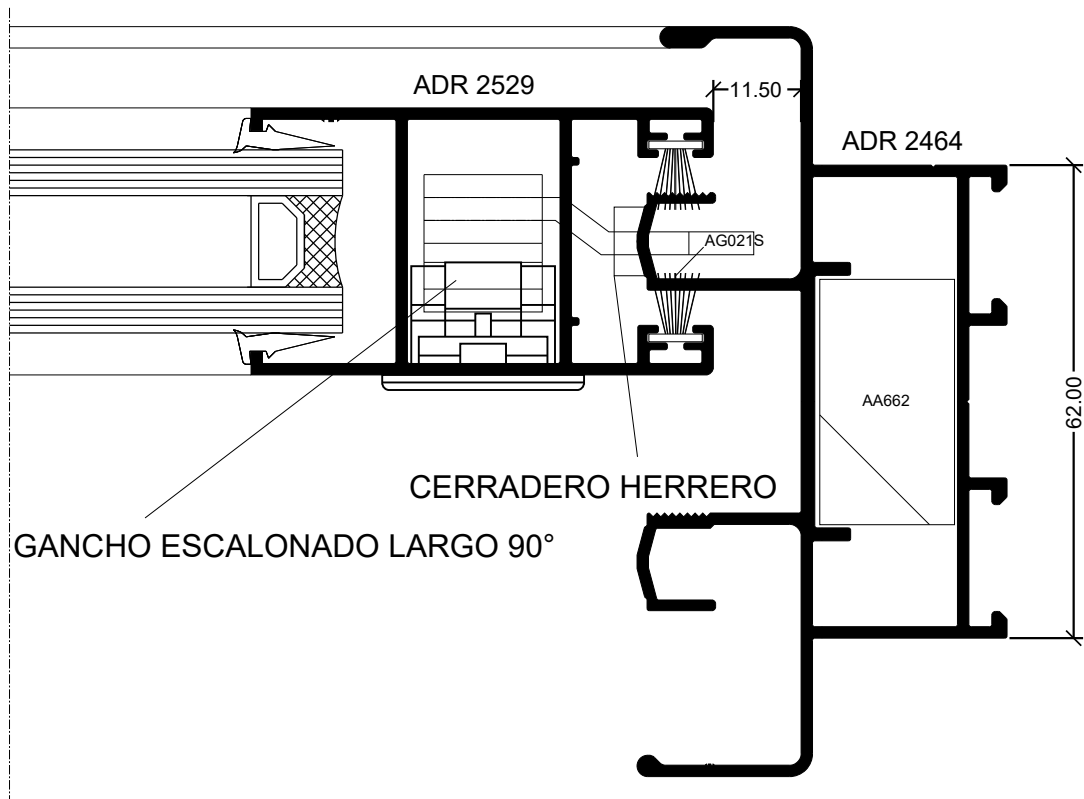

HA62 CORREDIZA

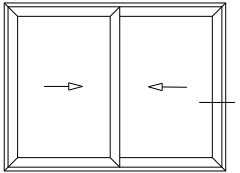

H56 + Cerradura - automático

Lateral Corrediza 2 hojas
Marco a 90° / Hoja a 90°

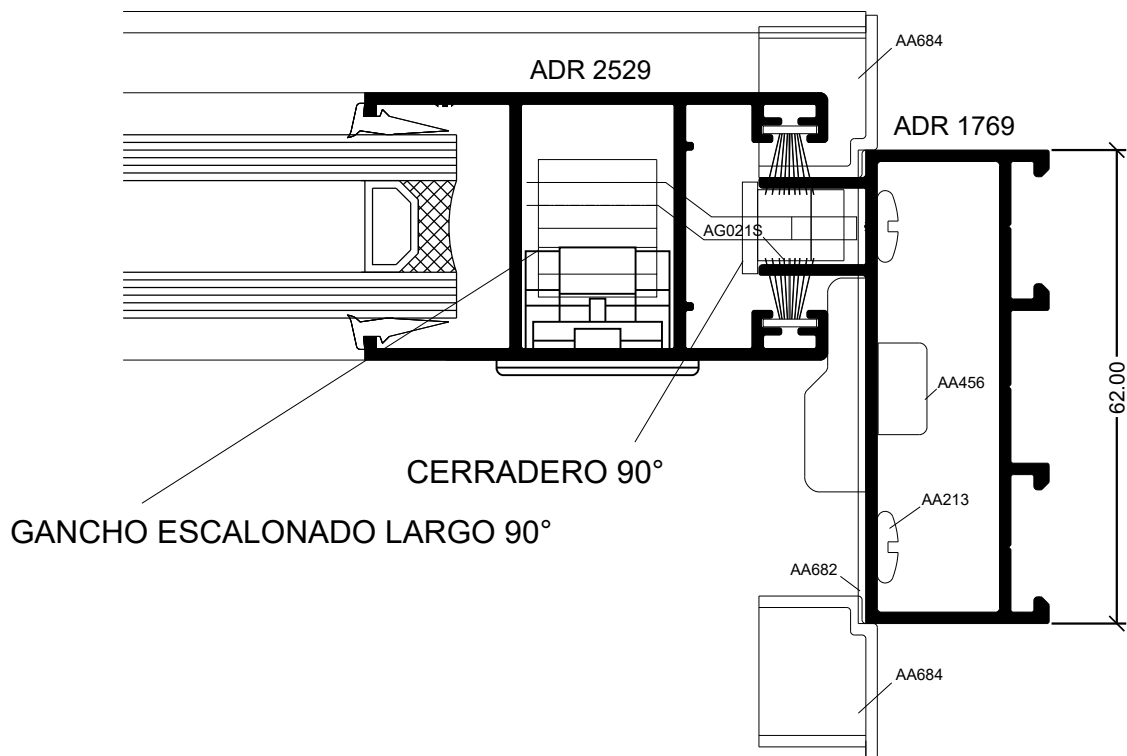

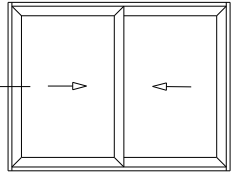

H56 + Cerradura - automático

Lateral Corrediza 2 hojas
Marco a 90° / Hoja a 45°

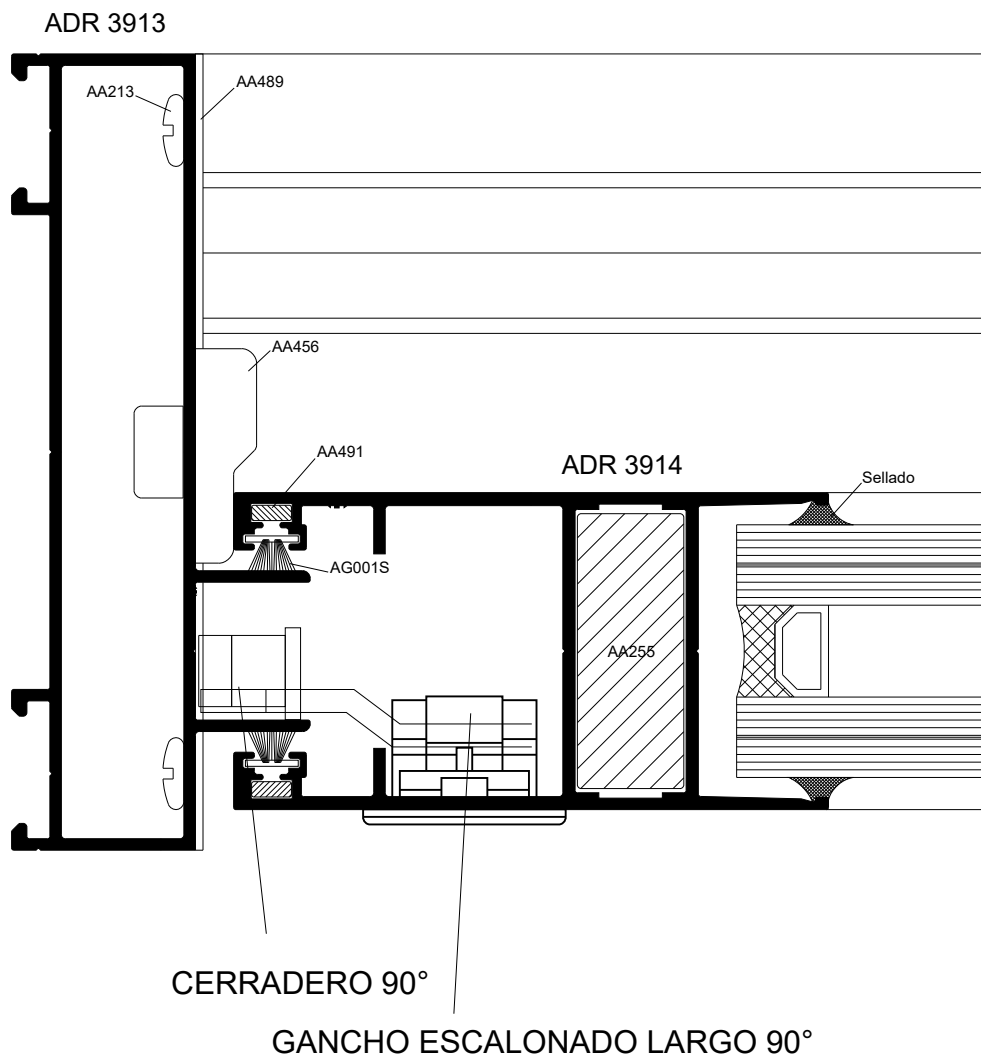

NÓRDICAL

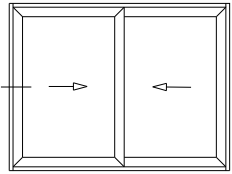

Lateral Izquierdo Corrediza 2 Hojas a 90°

H56 + Cerradura - automático

Lateral Corrediza 2 hojas
Marco a 90° / Hoja a 90°

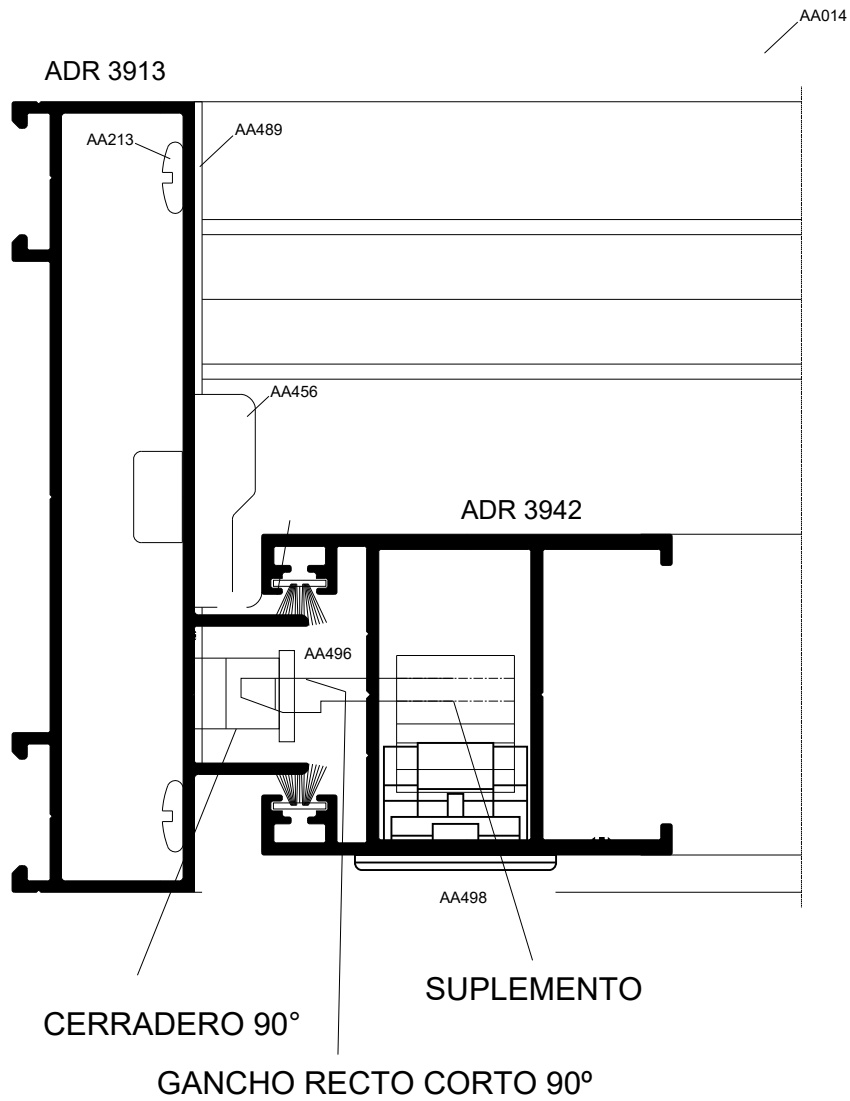

ORBITAL

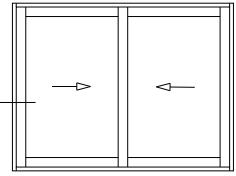

Lateral Corrediza 2 hojas + mosquitero

Marco a 90° / Hoja a 90°

H56 + Cerradura - automático

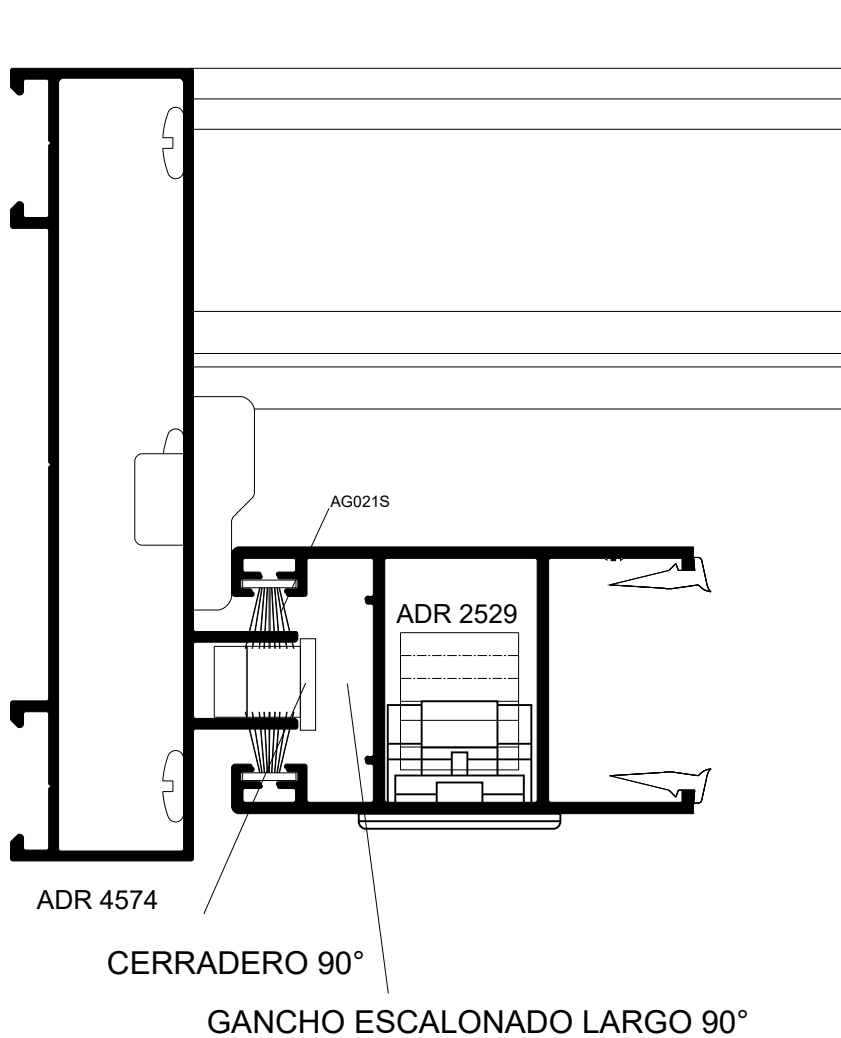

ORBITAL

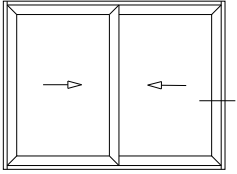

Lateral Corrediza 2 hojas + mosquitero

Marco a 90° / Hoja a 45°

H56 + Cerradura - automático

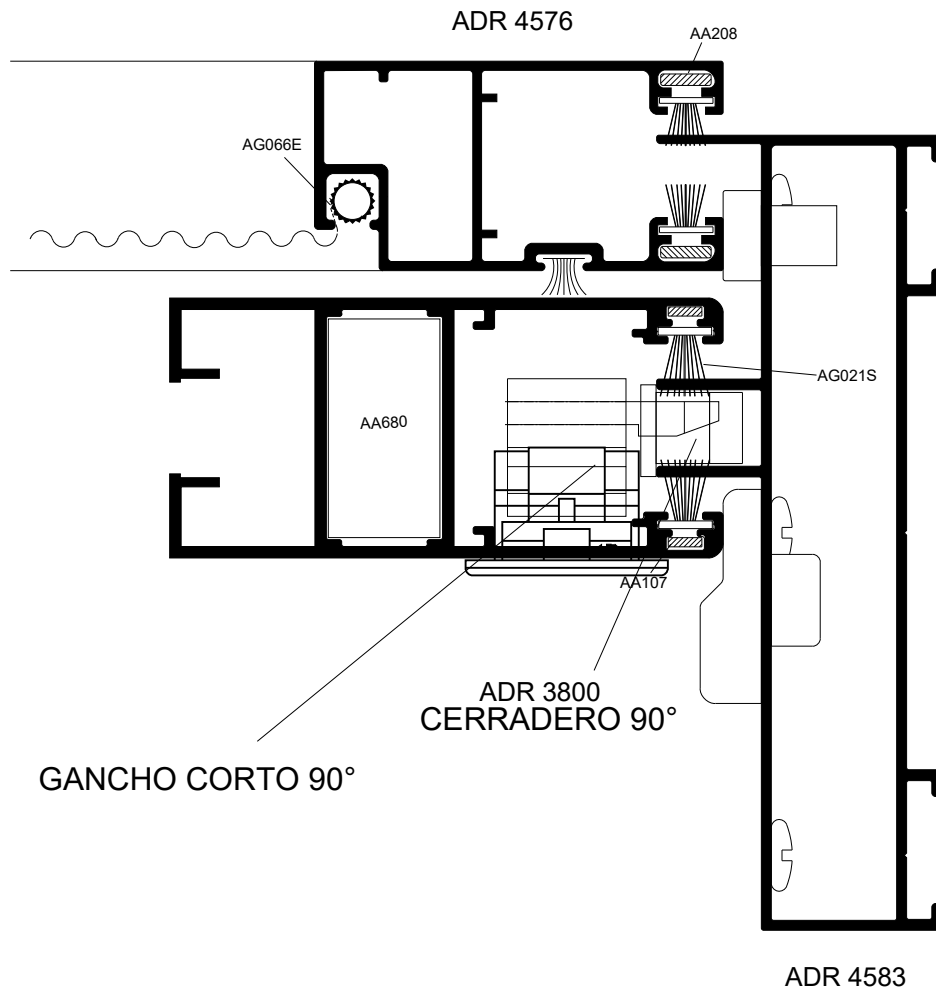

ORBITAL

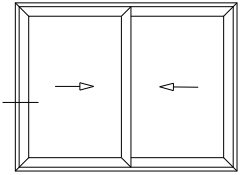

Lateral Corrediza 2 hojas + mosquitero

Marco a 45° / Hoja 45°

H56 + Cerradura - automático

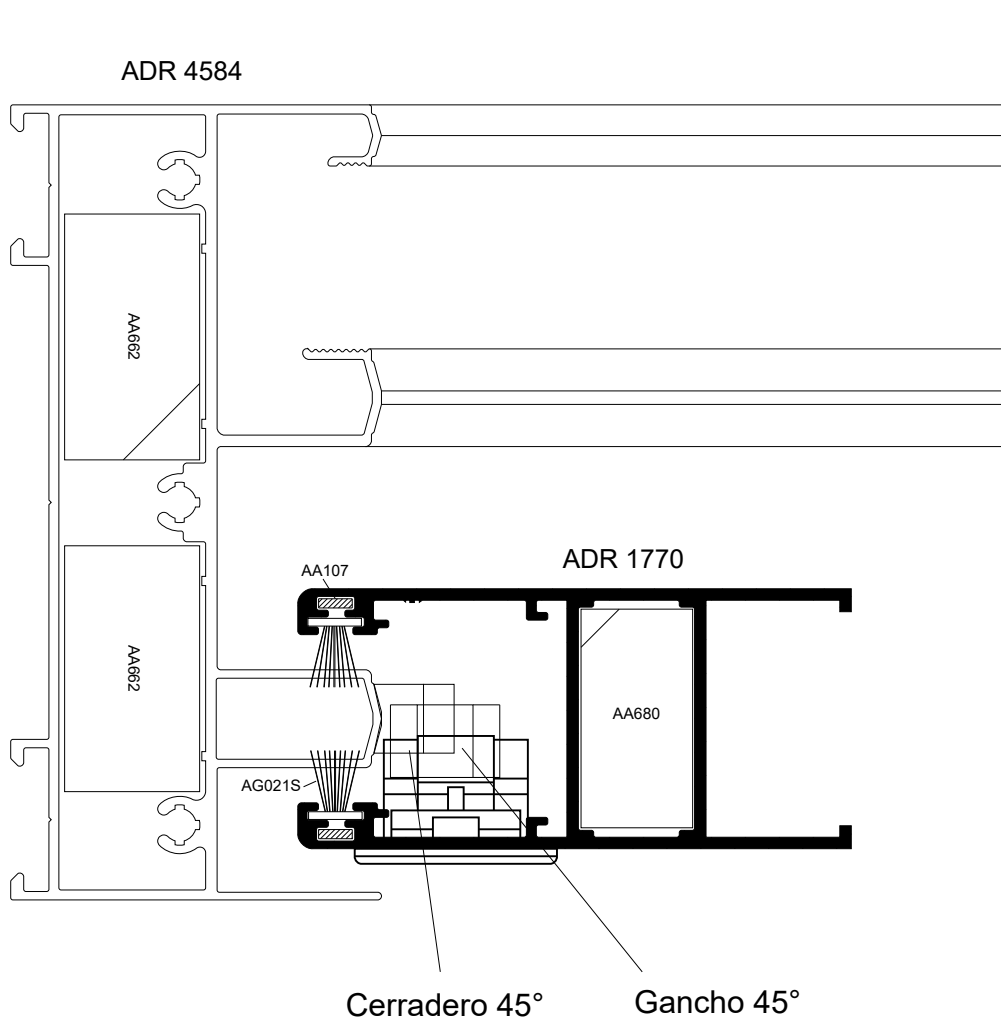

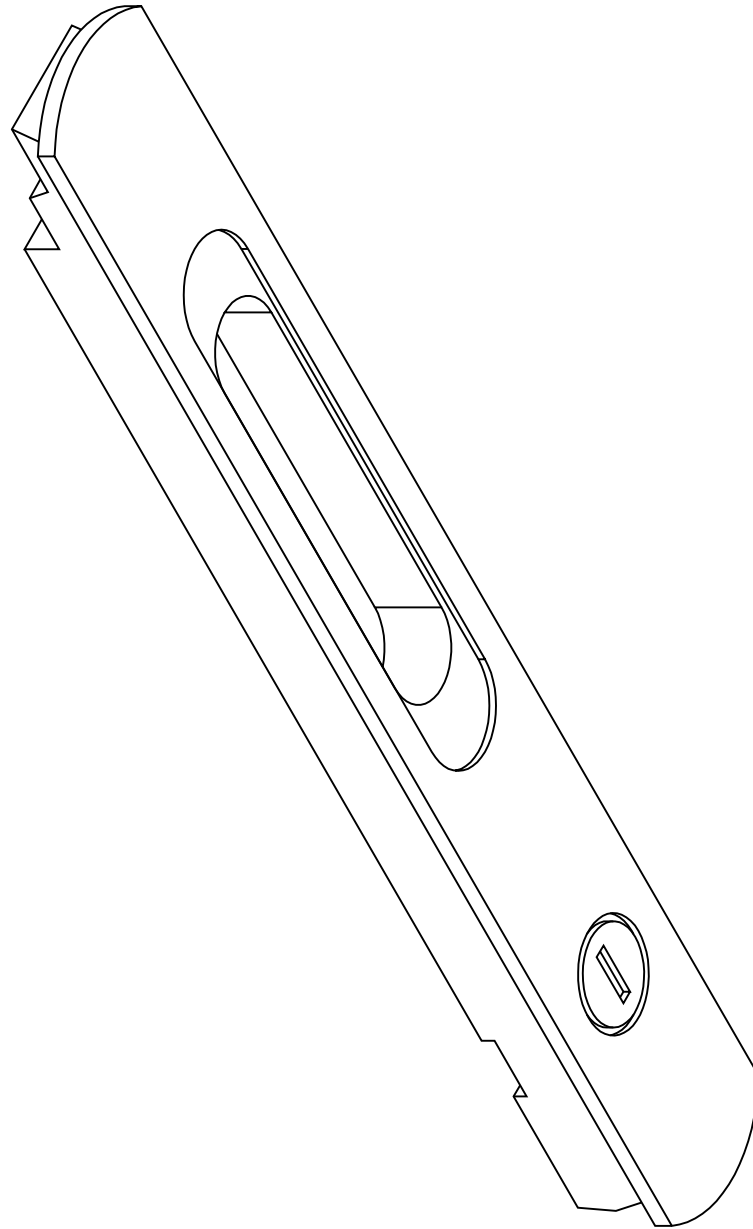

H56 PROIN zamak con llave para clipar
Escala 1:1

HA62 CORREDIZA

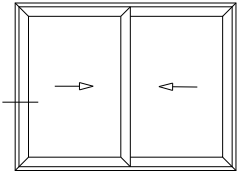

H56 PROIN zamak con llave para clipar

Lateral Corrediza 2 hojas
Marco a 45° / Hoja a 45°

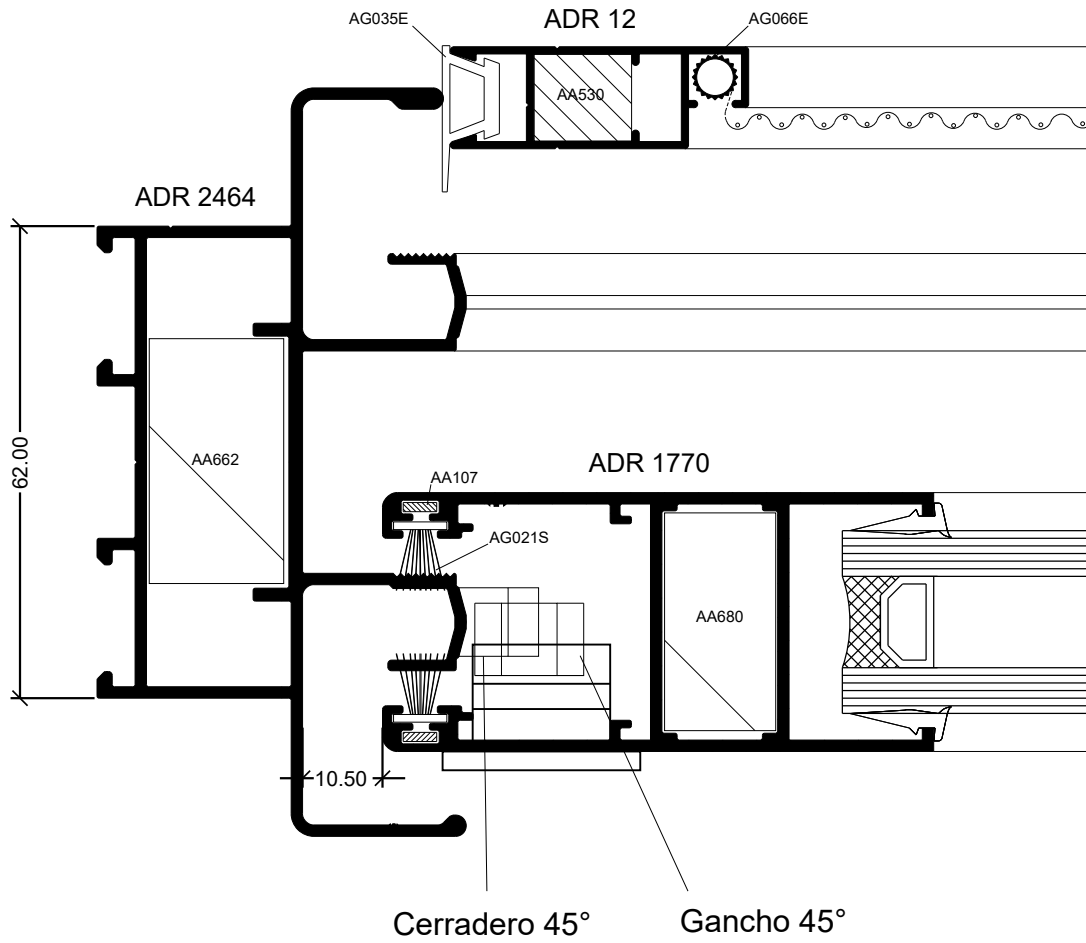

HA62 CORREDIZA

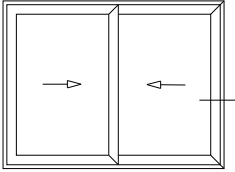

H56 PROIN zamak con llave para clipar

Lateral Corrediza 2 hojas
Marco a 45° / Hoja a 90°

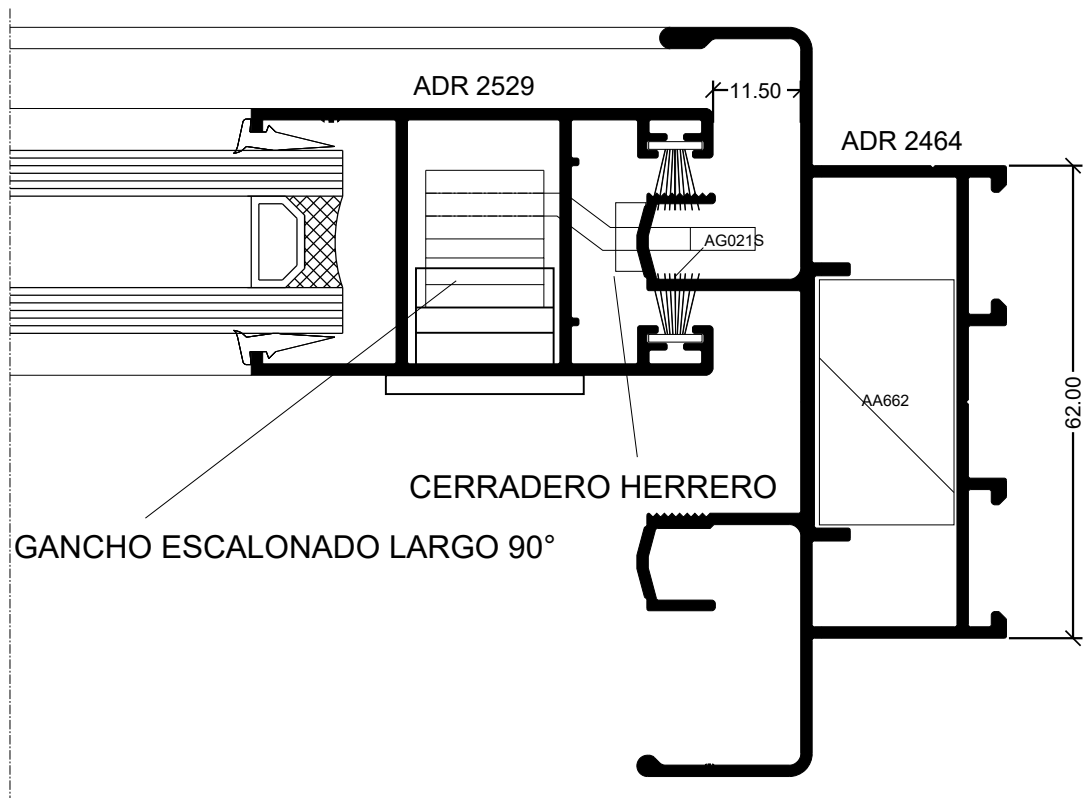

HA62 CORREDIZA

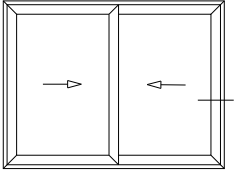

H56 PROIN zamak con llave para clipar

Lateral Corrediza 2 hojas
Marco a 90° / Hoja a 90°

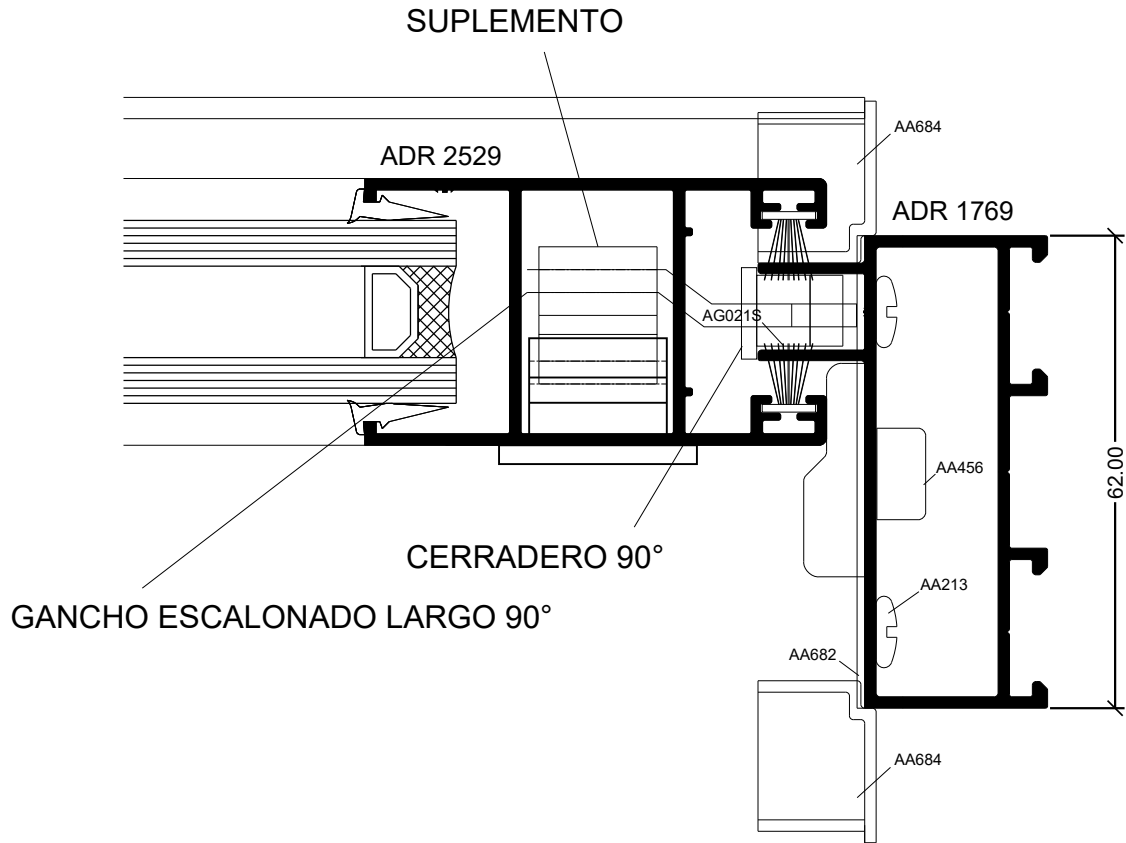

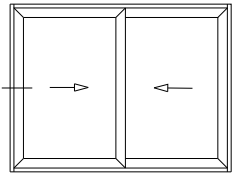

H56 PROIN zamak con llave para clipar

Lateral Corrediza 2 hojas
Marco a 90° / Hoja a 45°

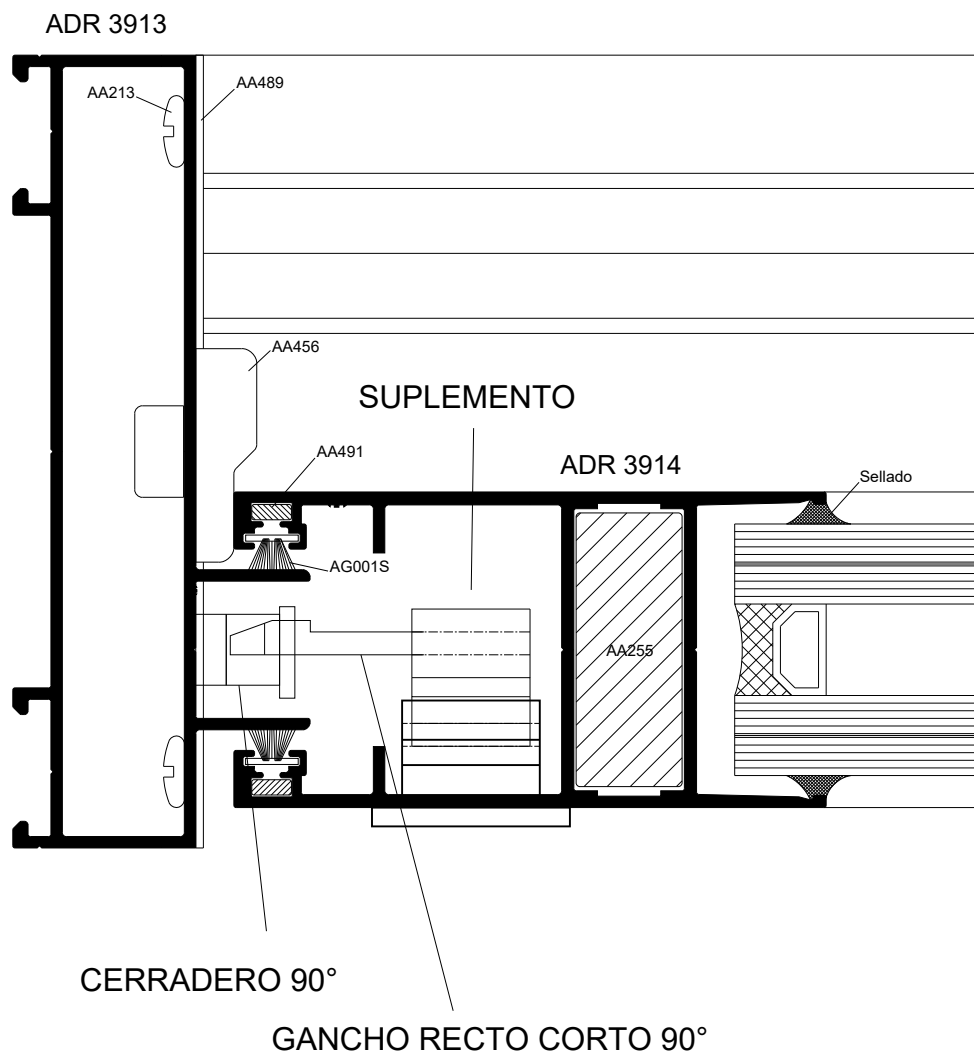

NÓRDICAL

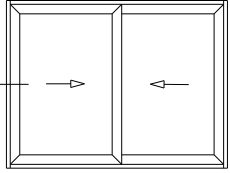

H56 PROIN zamak con llave para clipar

Lateral Corrediza 2 hojas
Marco a 90° / Hoja a 90°

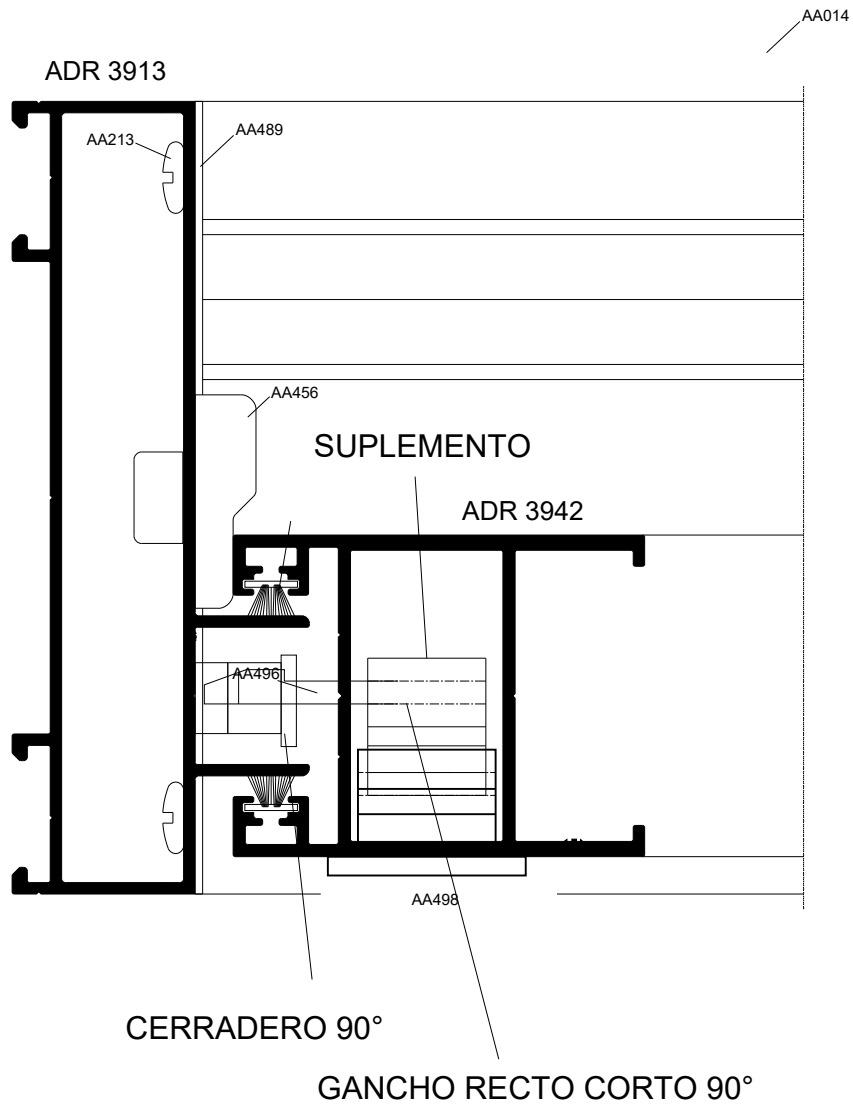

ORBITAL

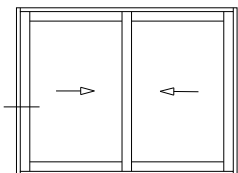

H56 PROIN zamak con llave para clipar

Marco a 90° / Hoja a 90°

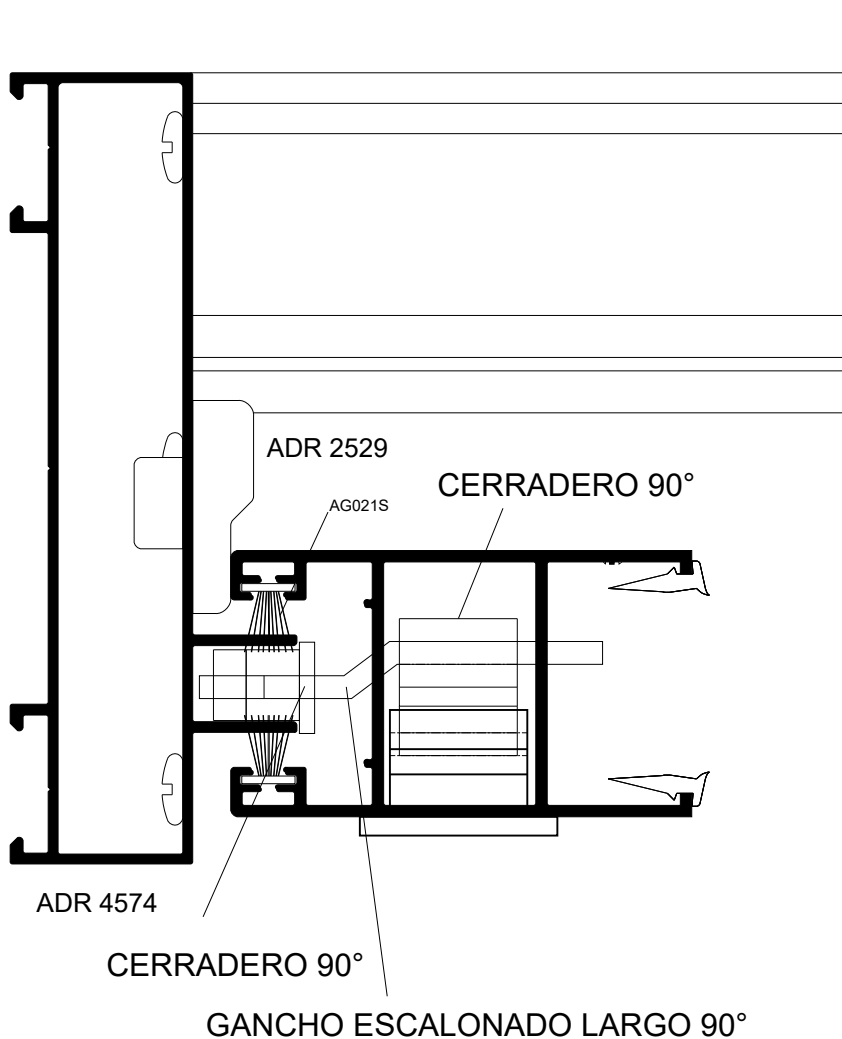

ORBITAL

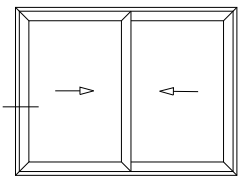

H56 PROIN zamak con llave para clipar

Marco a 45° / Hoja 45°

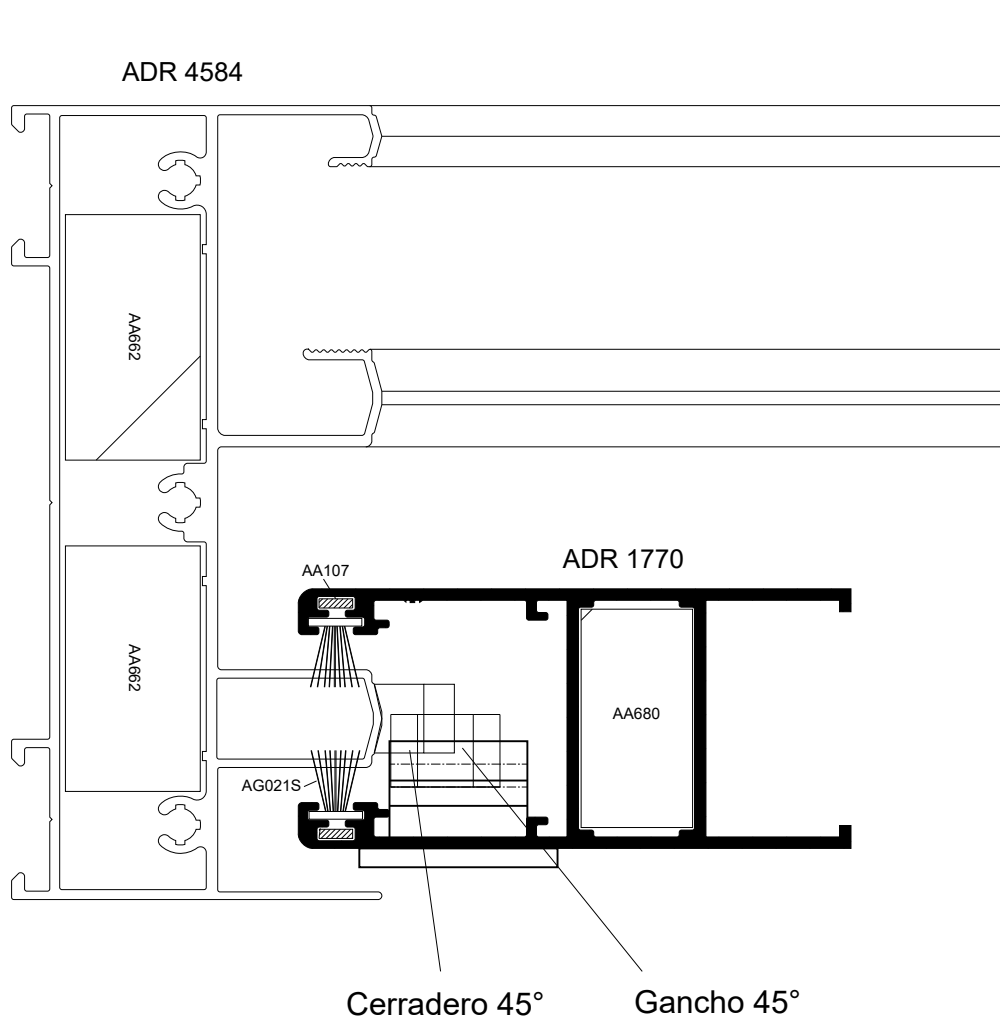

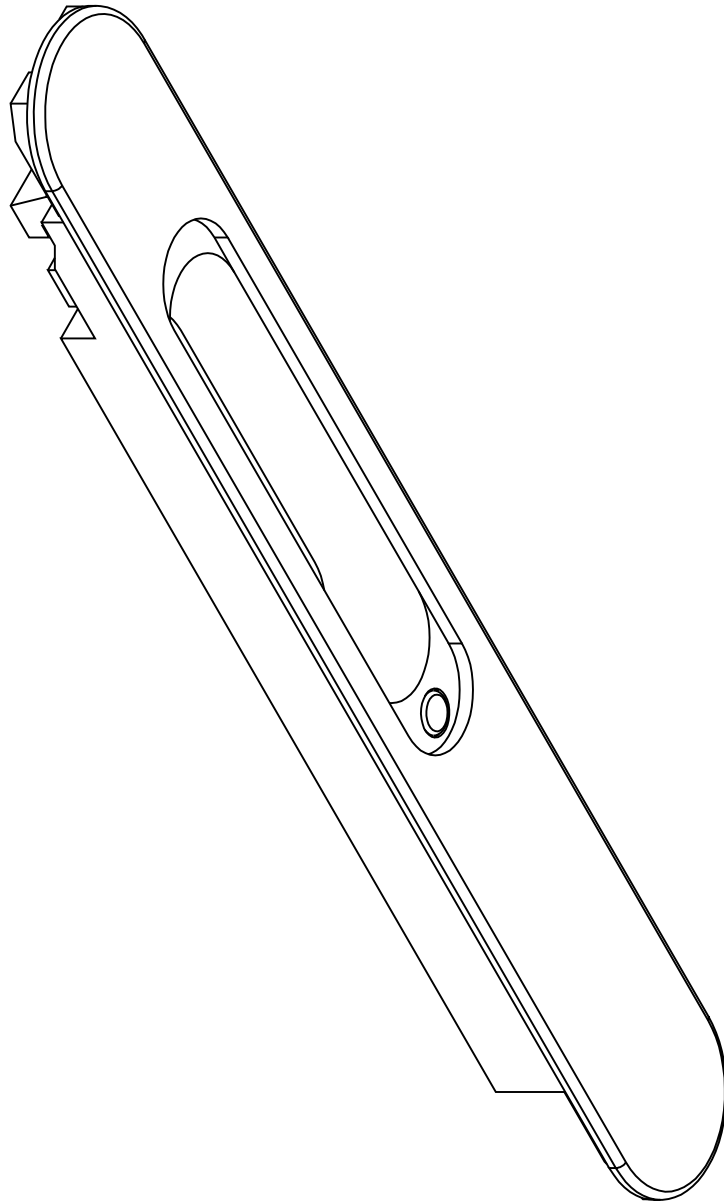

H56 PROIN para clipar
Escala 1:1

HA62 CORREDIZA

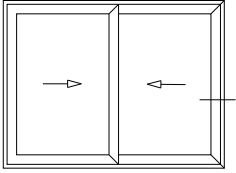

H56 PROIN para clipar

Lateral Corrediza 2 hojas
Marco a 45° / Hoja a 90°

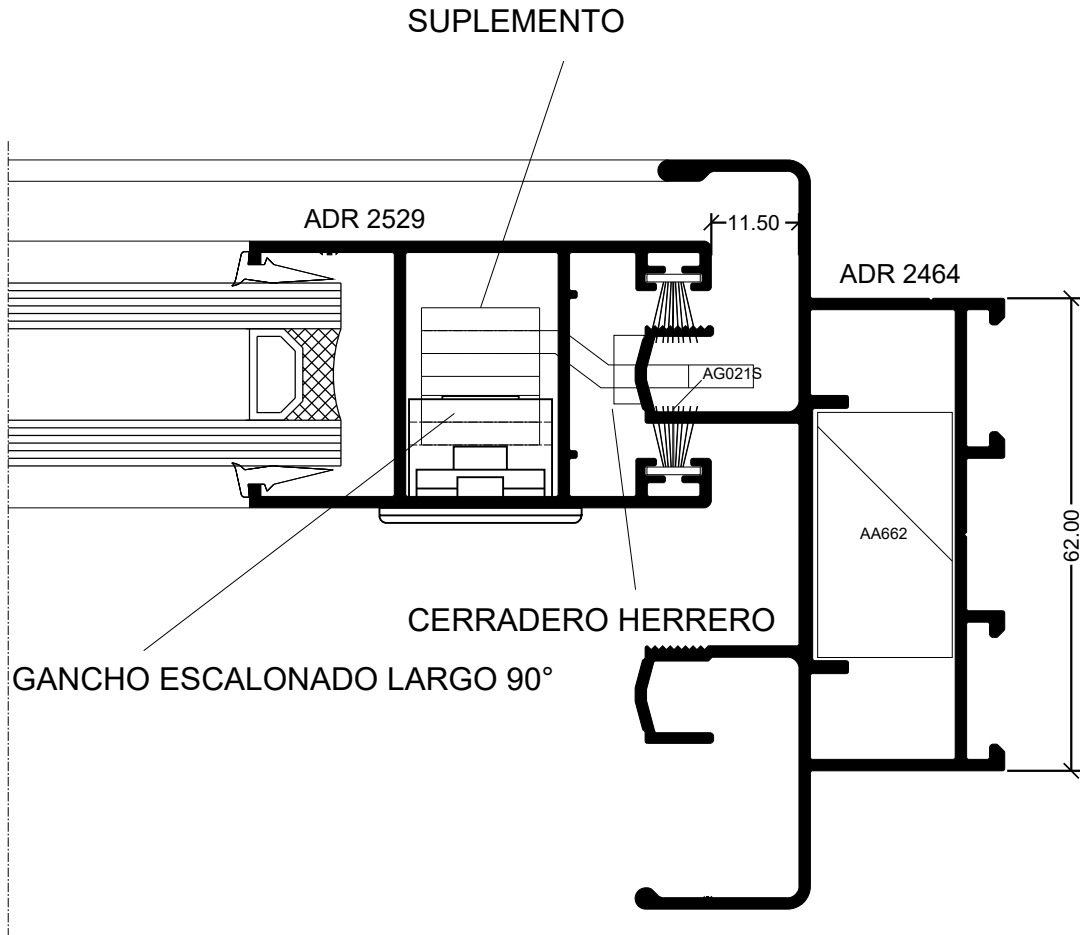

HA62 CORREDIZA

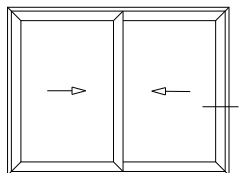

H56 PROIN para clipar

Lateral Corrediza 2 hojas
Marco a 90° / Hoja a 90°

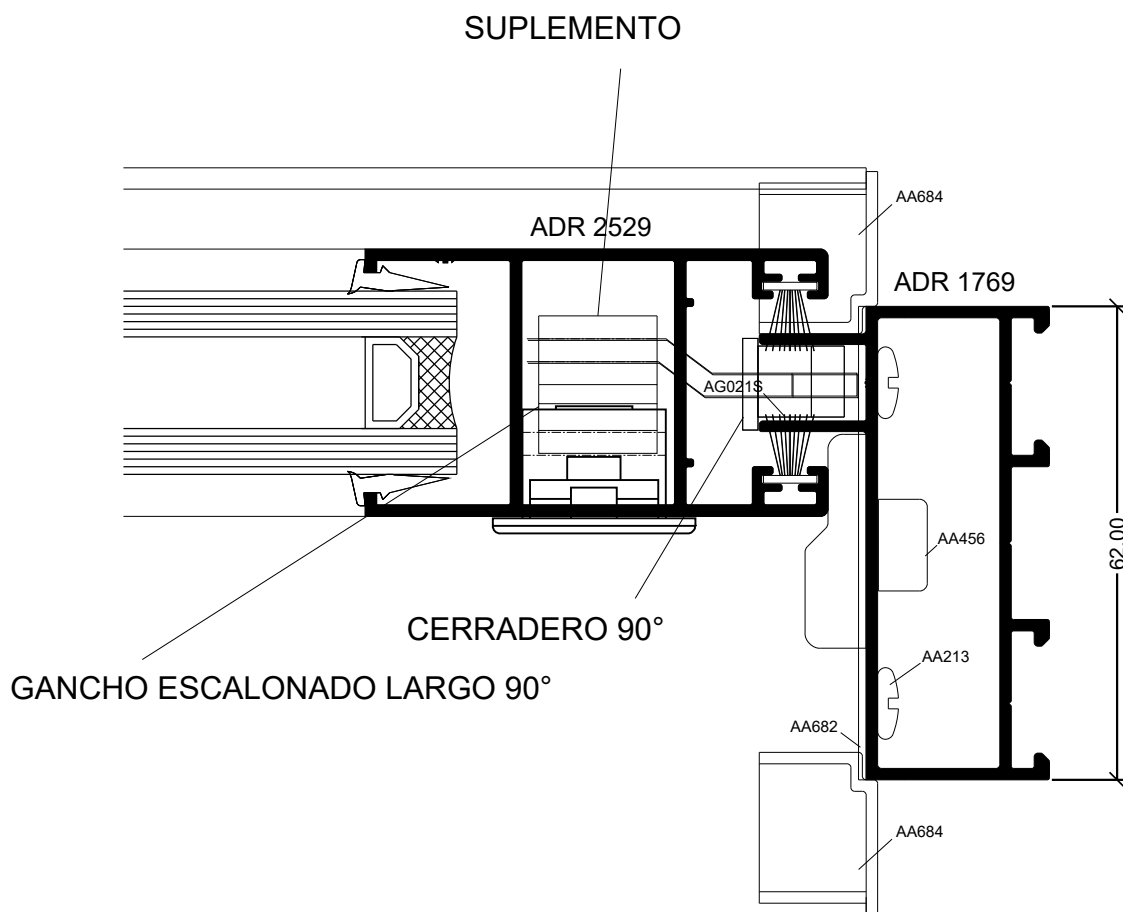

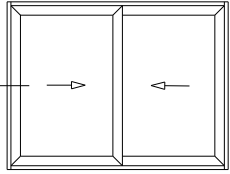

H56 PROIN para clipar

Lateral Corrediza 2 hojas
Marco a 90° / Hoja a 45°

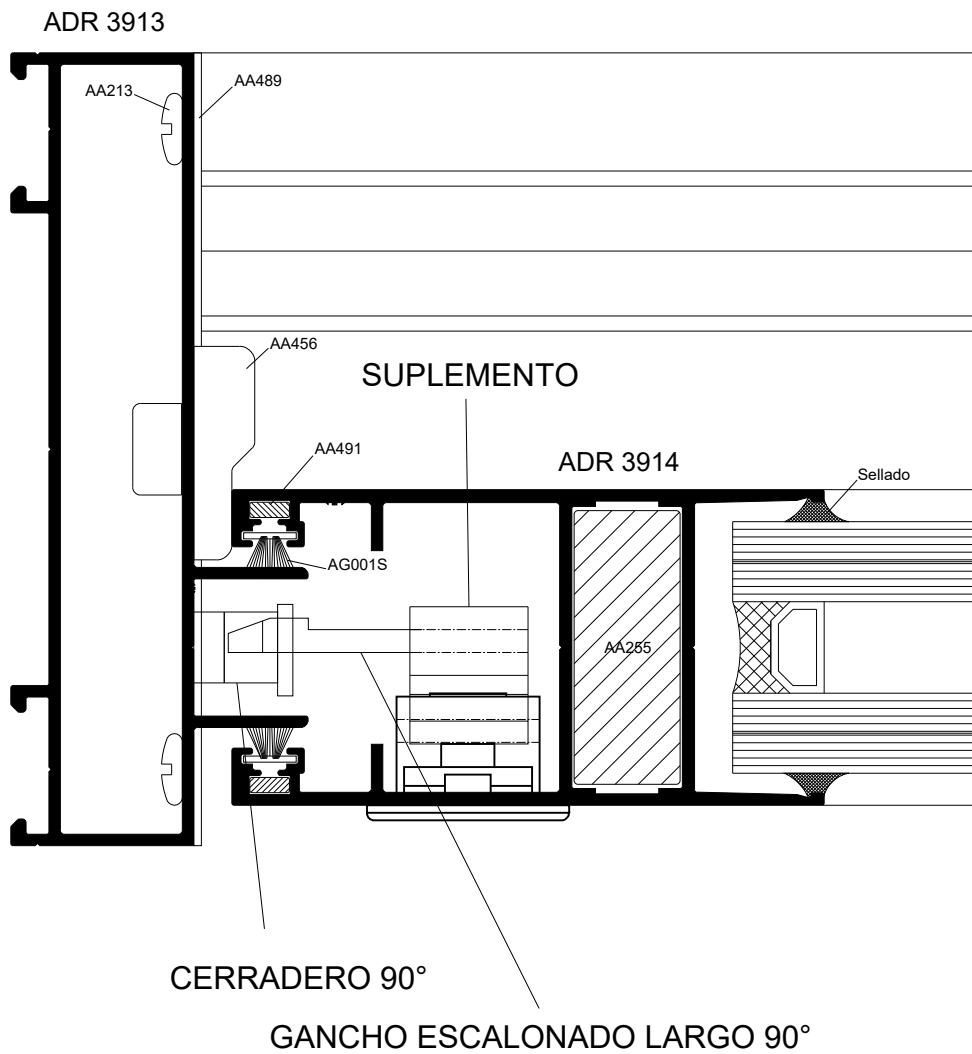

NÓRDICAL

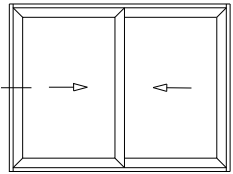

Lateral Izquierdo Corrediza 2 Hojas a 90°

H56 PROIN para clipar

Lateral Corrediza 2 hojas
Marco a 90° / Hoja a 90°

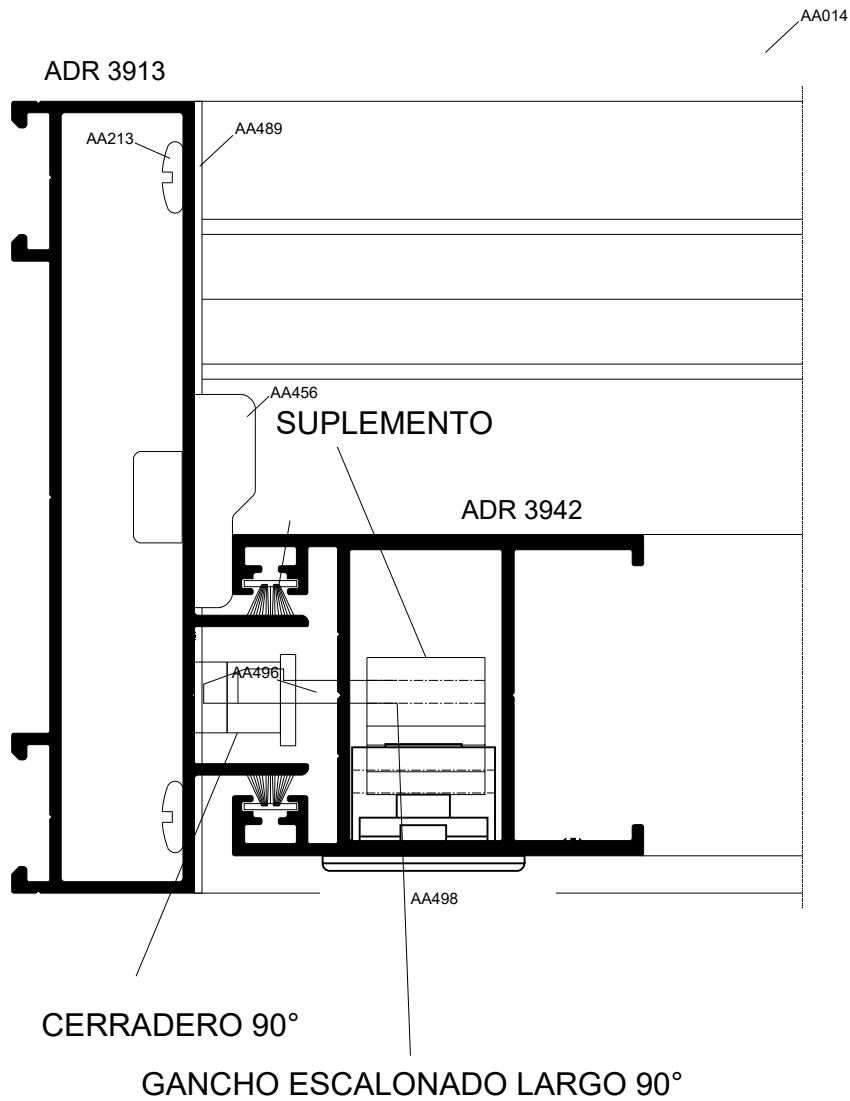

ORBITAL

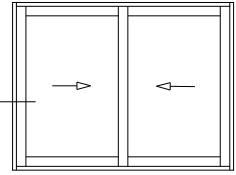

PROiN



La Aldaba



Hydro

H56 PROIN para clipar

Lateral Corrediza 2 hojas + mosquitero

Marco a 90° / Hoja a 90°

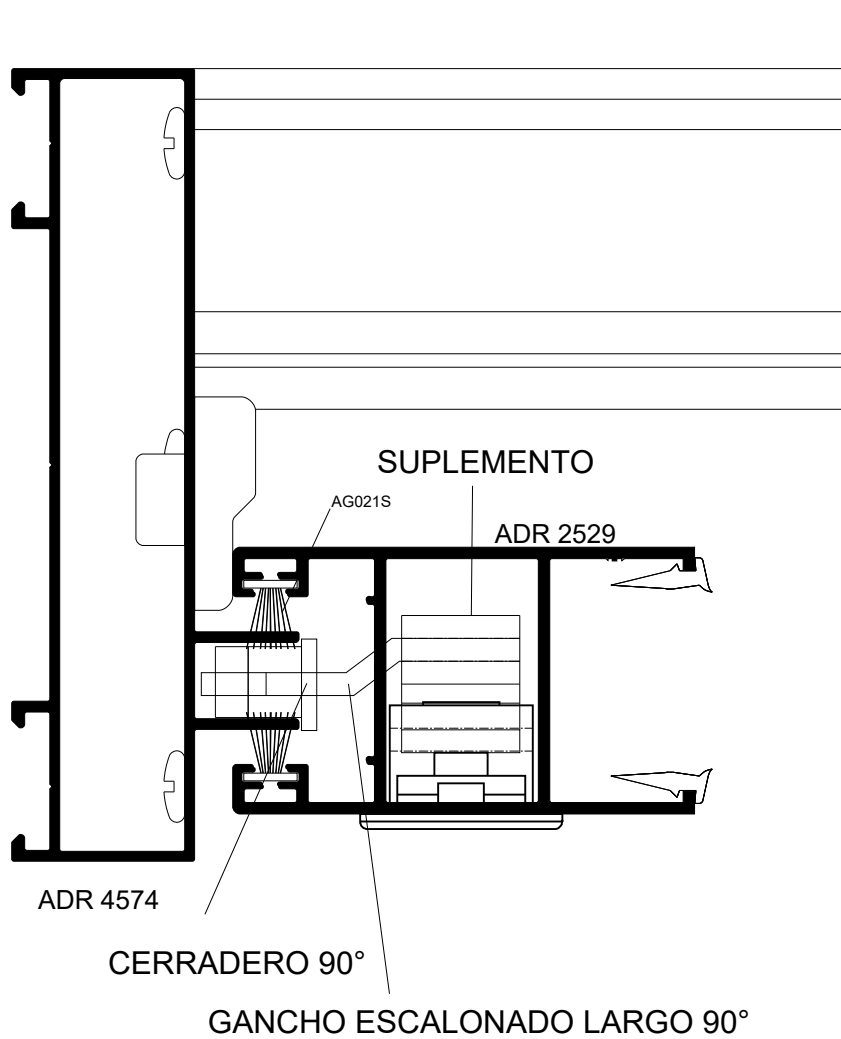

ORBITAL

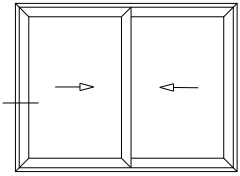

H56 PROIN para clipar
Lateral Corrediza 2 hojas + mosquitero
Marco a 45° / Hoja 45°

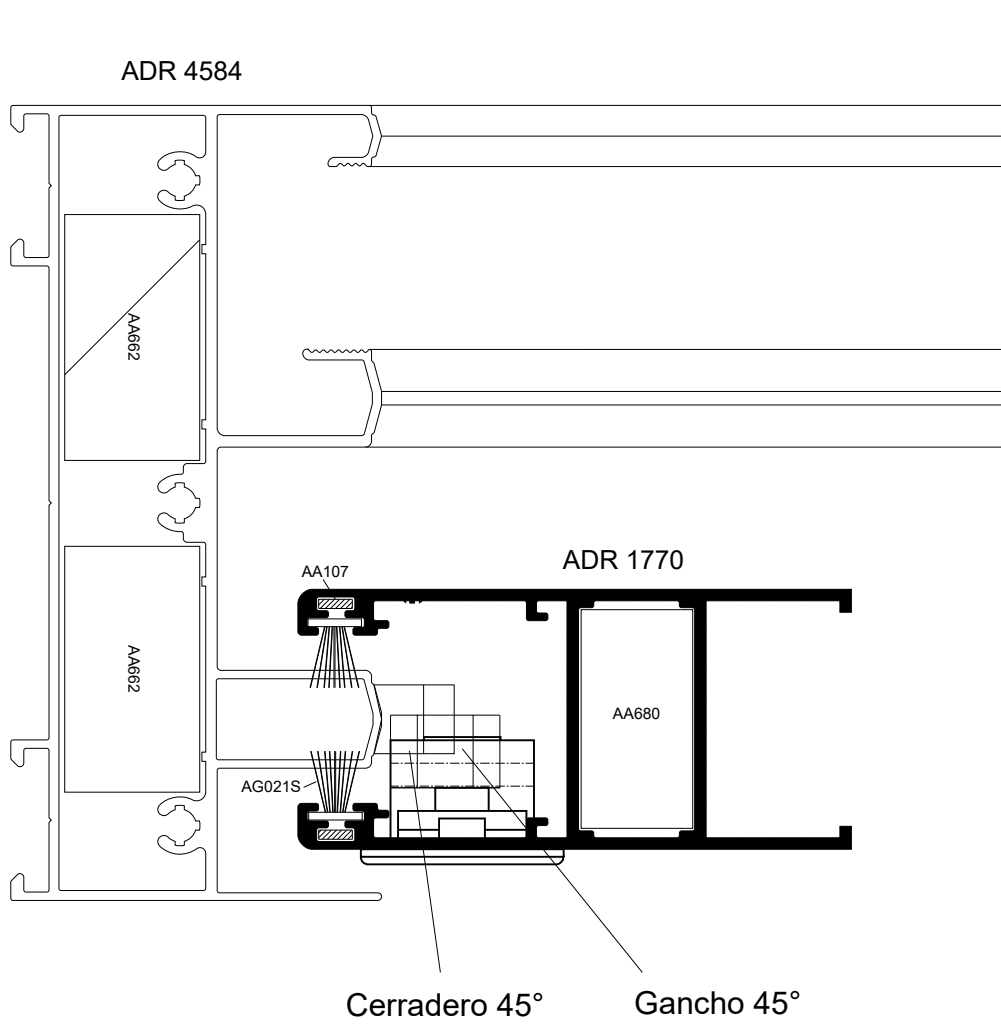

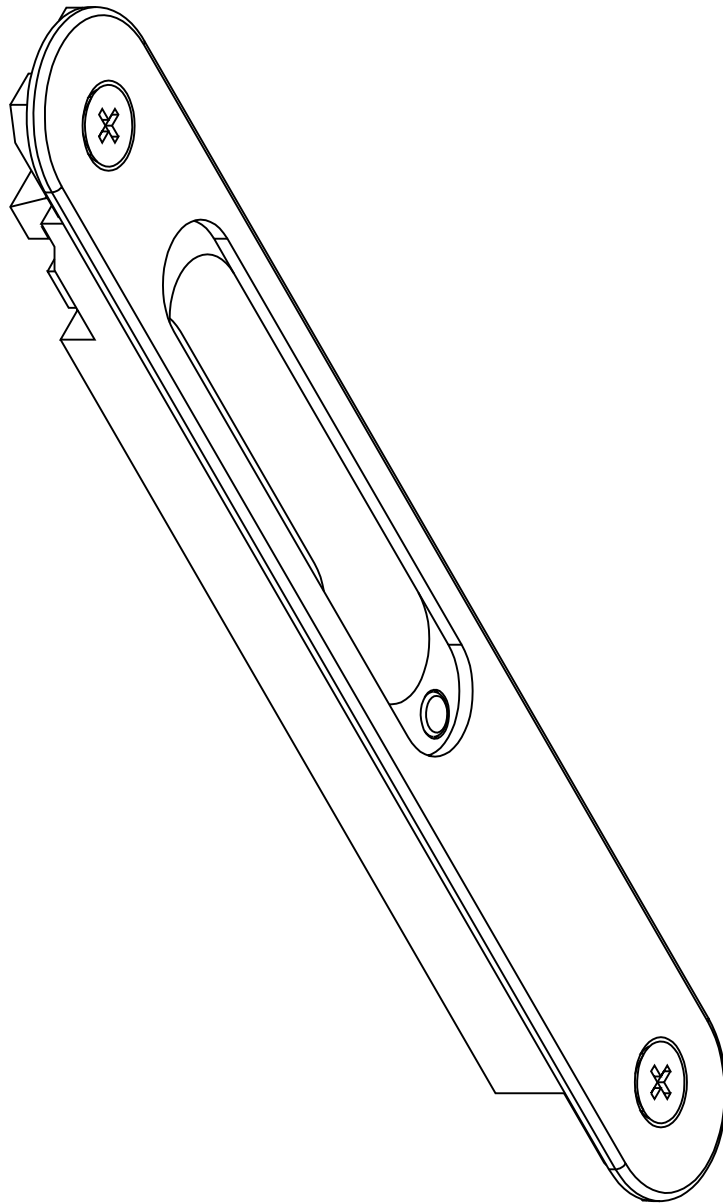

H56 PROIN
Escala 1:1

HA62 CORREDIZA

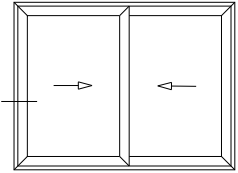

H56 PROIN

Lateral Corrediza 2 hojas
Marco a 45° / Hoja a 45°

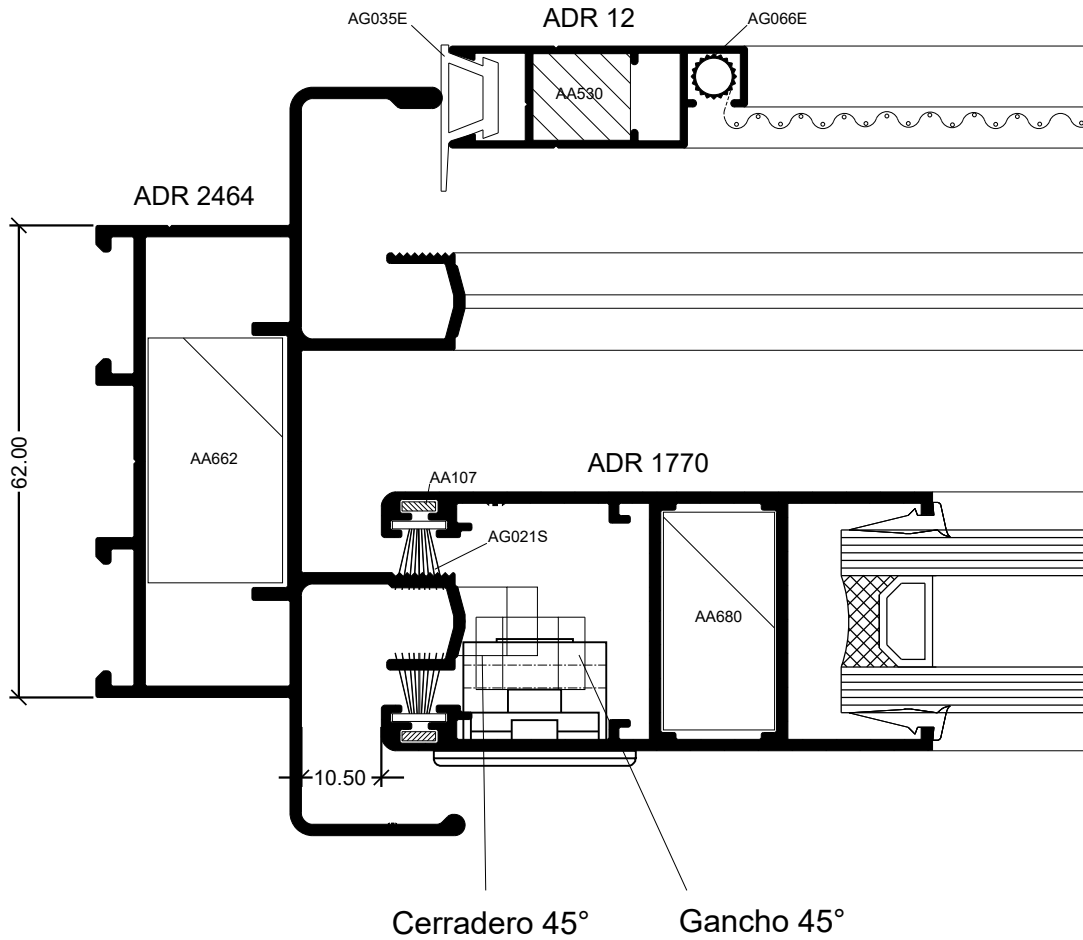

HA62 CORREDIZA



La Aldaba® Hydro

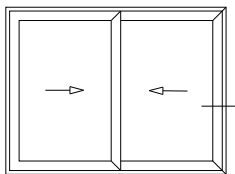

H56 PROIN

Lateral Corrediza 2 hojas
Marco a 45° / Hoja a 90°

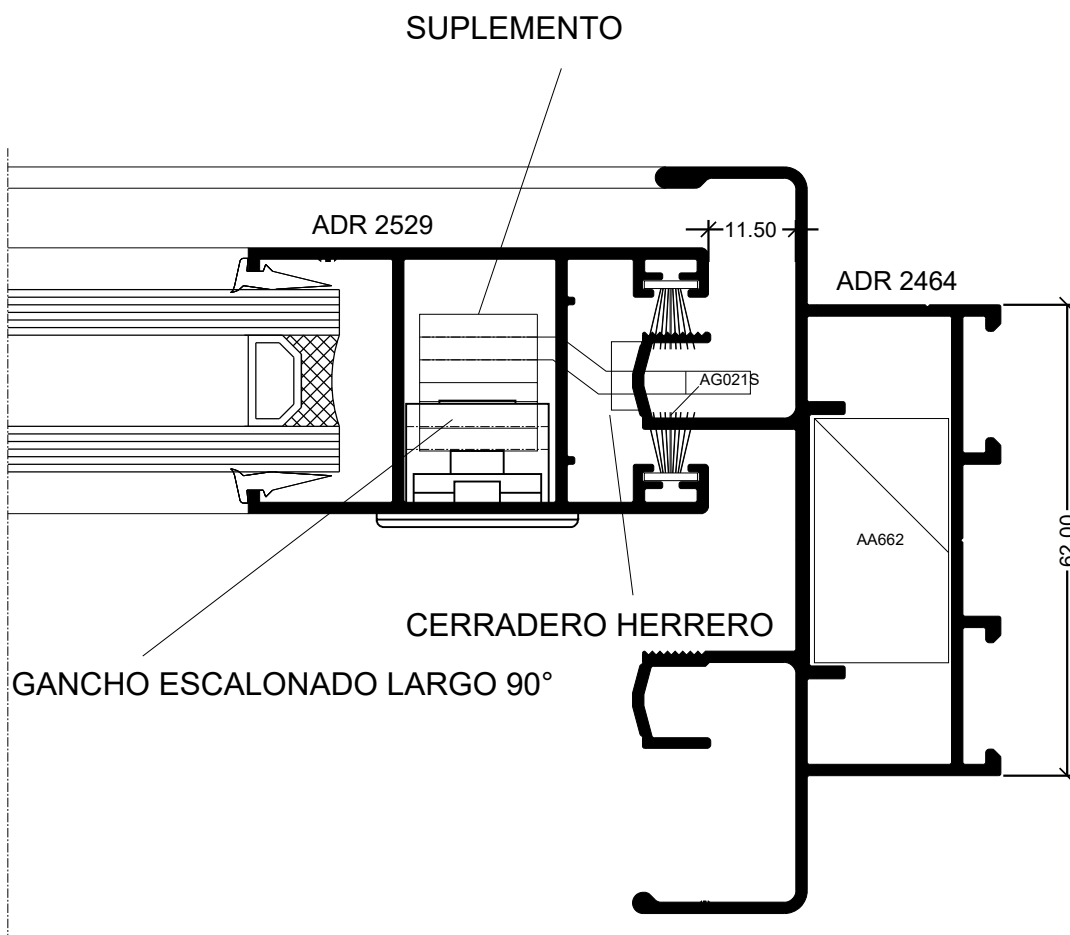

HA62 CORREDIZA

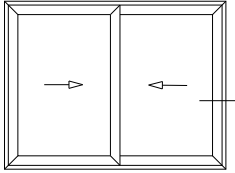

H56 PROIN

Lateral Corrediza 2 hojas
Marco a 90° / Hoja a 90°

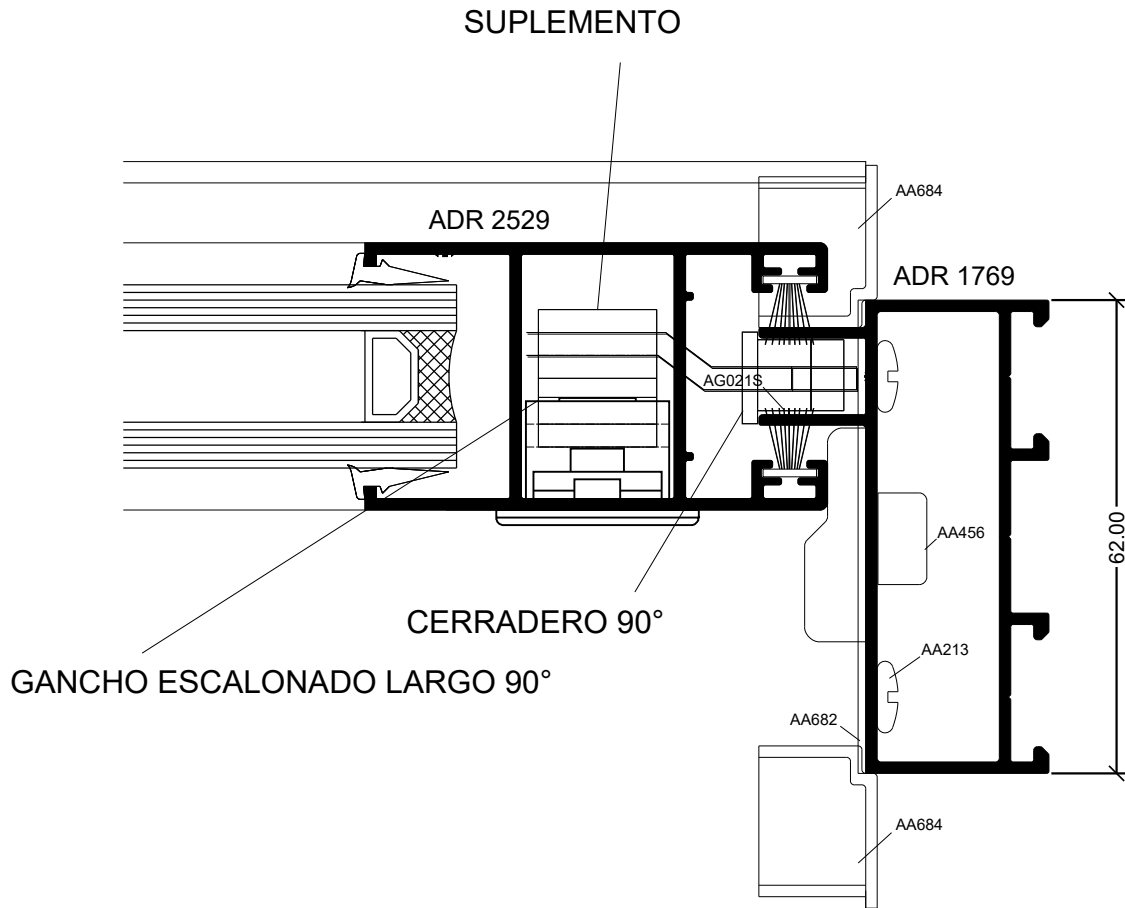

NÓRDICAL

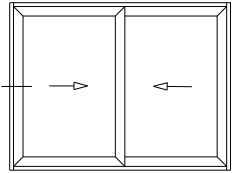

PROiN

La Aldaba

Hydro

H56 PROIN

Lateral Corrediza 2 hojas
Marco a 90° / Hoja a 45°

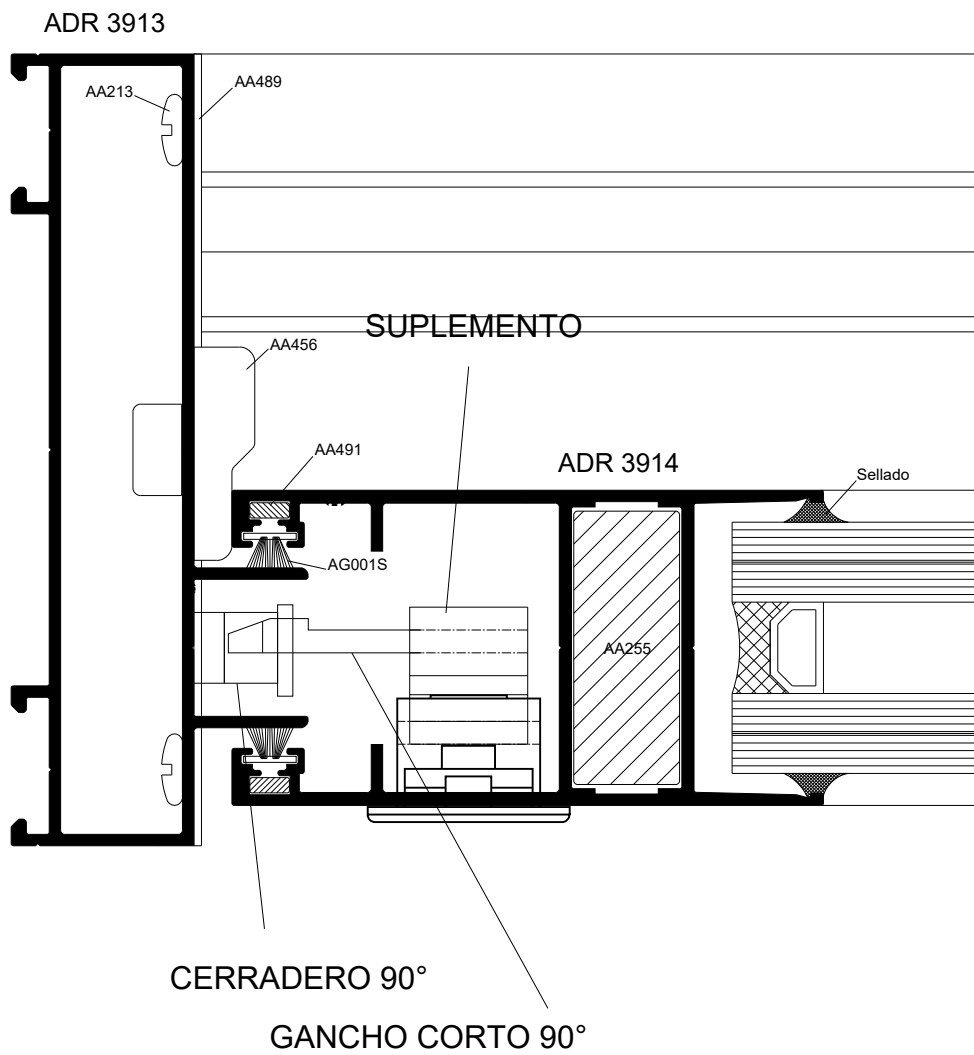

NÓRDICAL

Lateral Izquierdo Corrediza 2 Hojas a 90°

H56 PROIN

Lateral Corrediza 2 hojas
Marco a 90° / Hoja a 90°

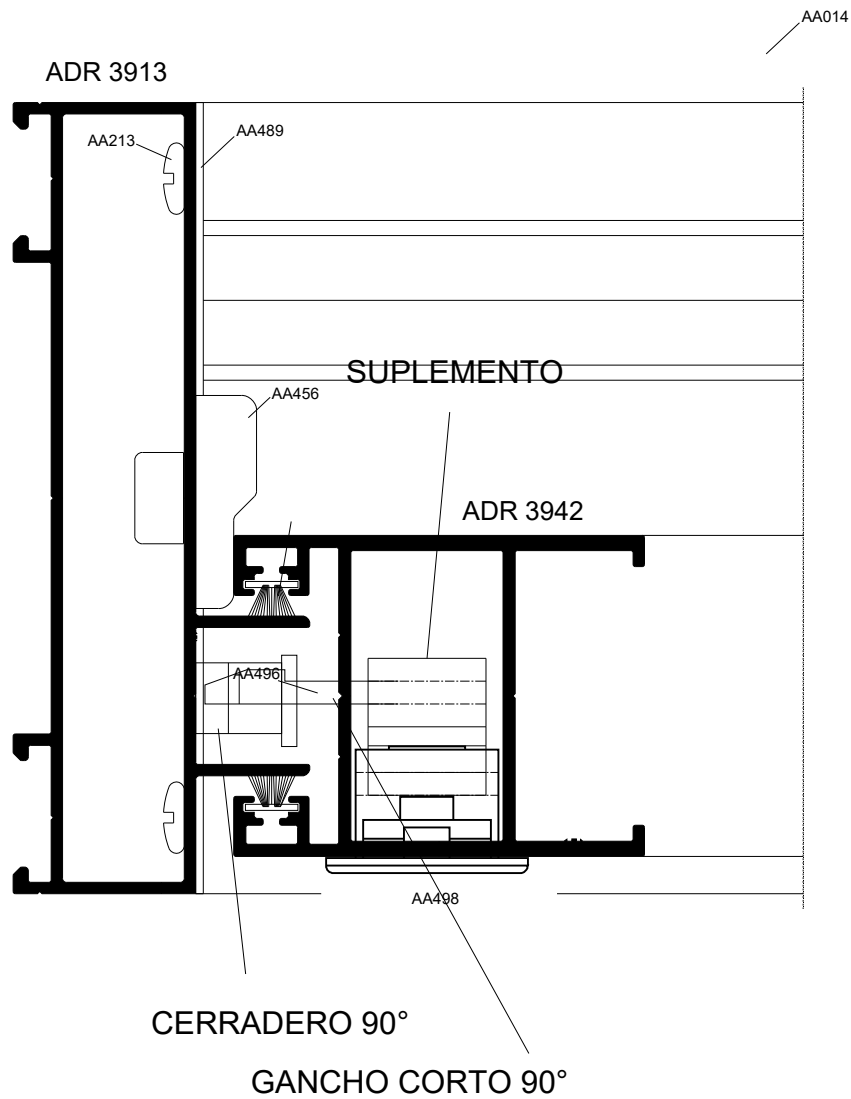
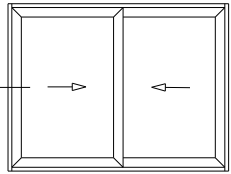

ORBITAL

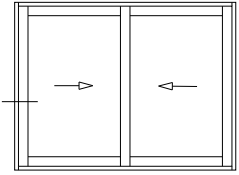

H56 PROIN

Lateral Corrediza 2 hojas + mosquitero
Marco a 90° / Hoja a 90°

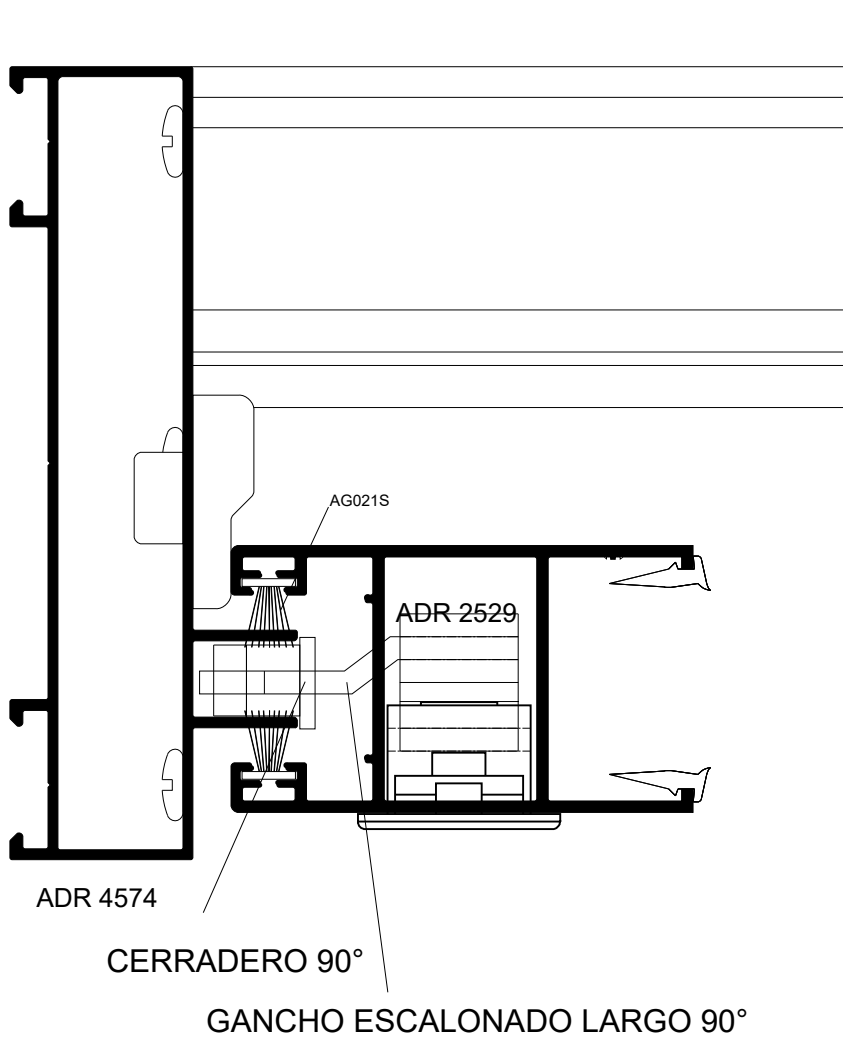

ORBITAL

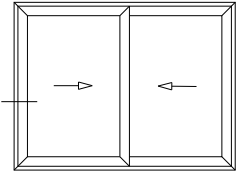

PROiN



La Aldaba



Hydro

H56 PROIN
Lateral Corrediza 2 hojas + mosquitero

Marco a 45° / Hoja 45°

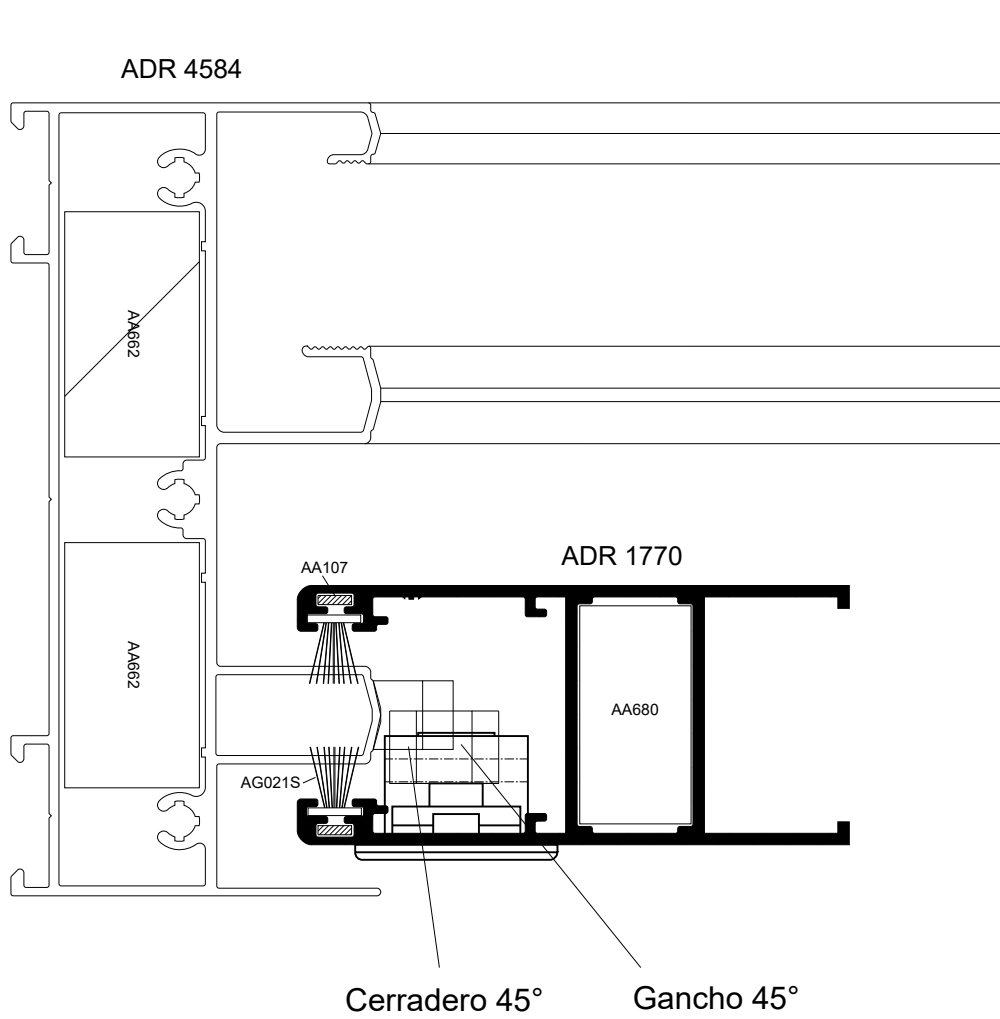

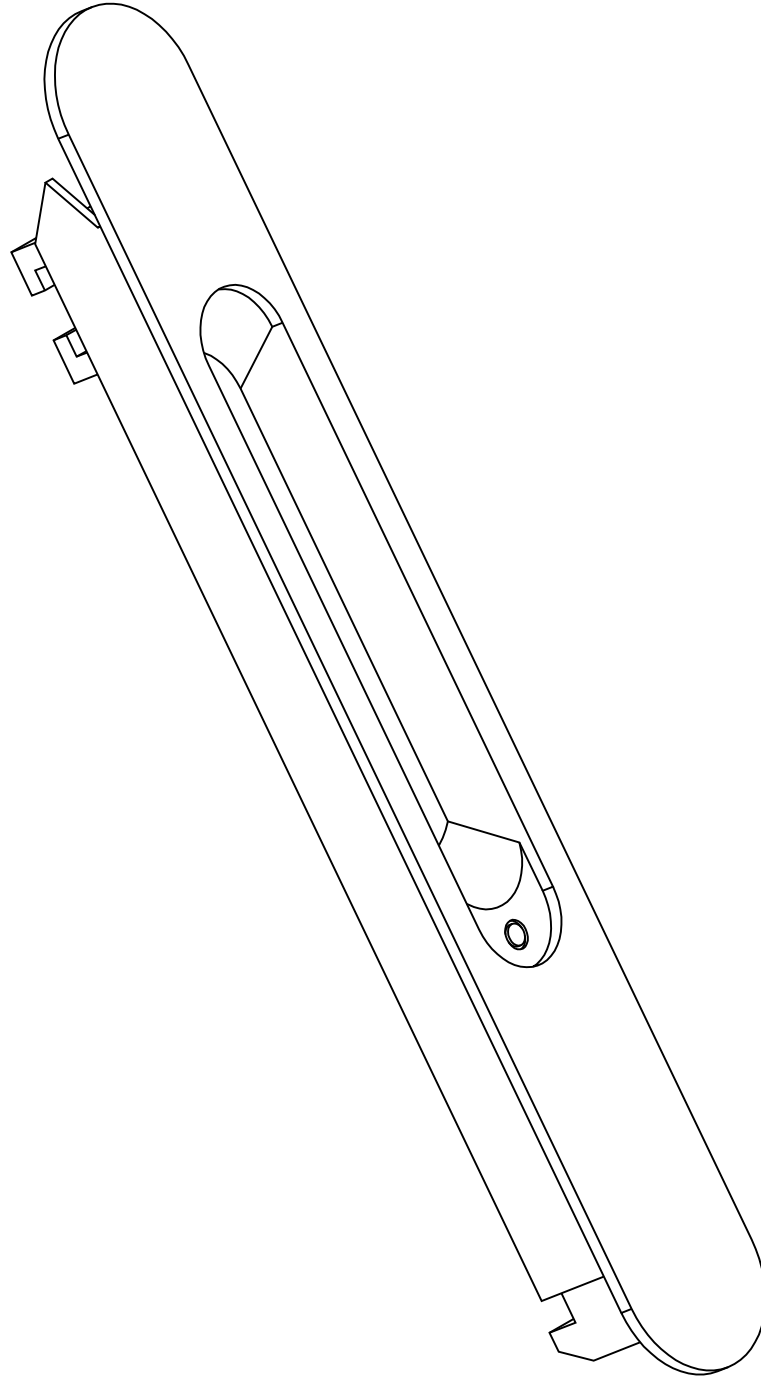

H56 CH - Clipar
Escala 1:1

HA62 CORREDIZA

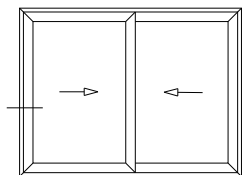

H56 CH - Clipar

Lateral Corrediza 2 hojas
Marco a 90° / Hoja a 45°

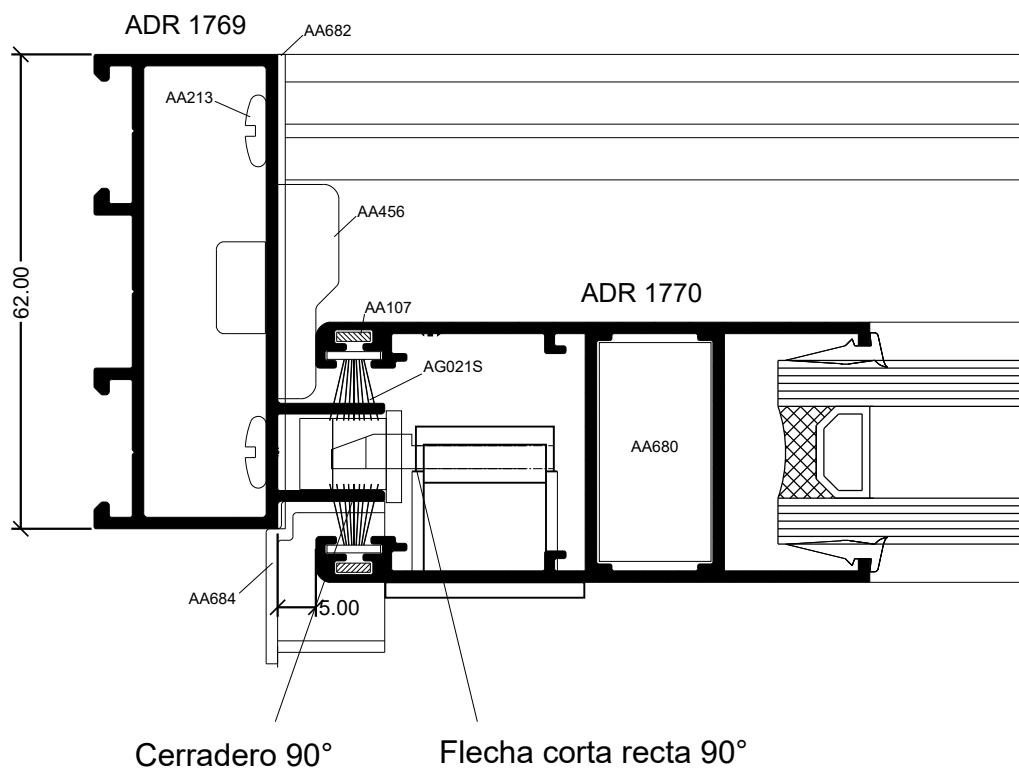

HA62 CORREDIZA

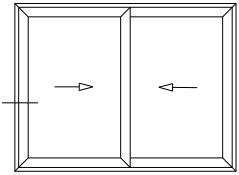

H56 CH - Clipar

Lateral Corrediza 2 hojas
Marco a 45° / Hoja a 45°

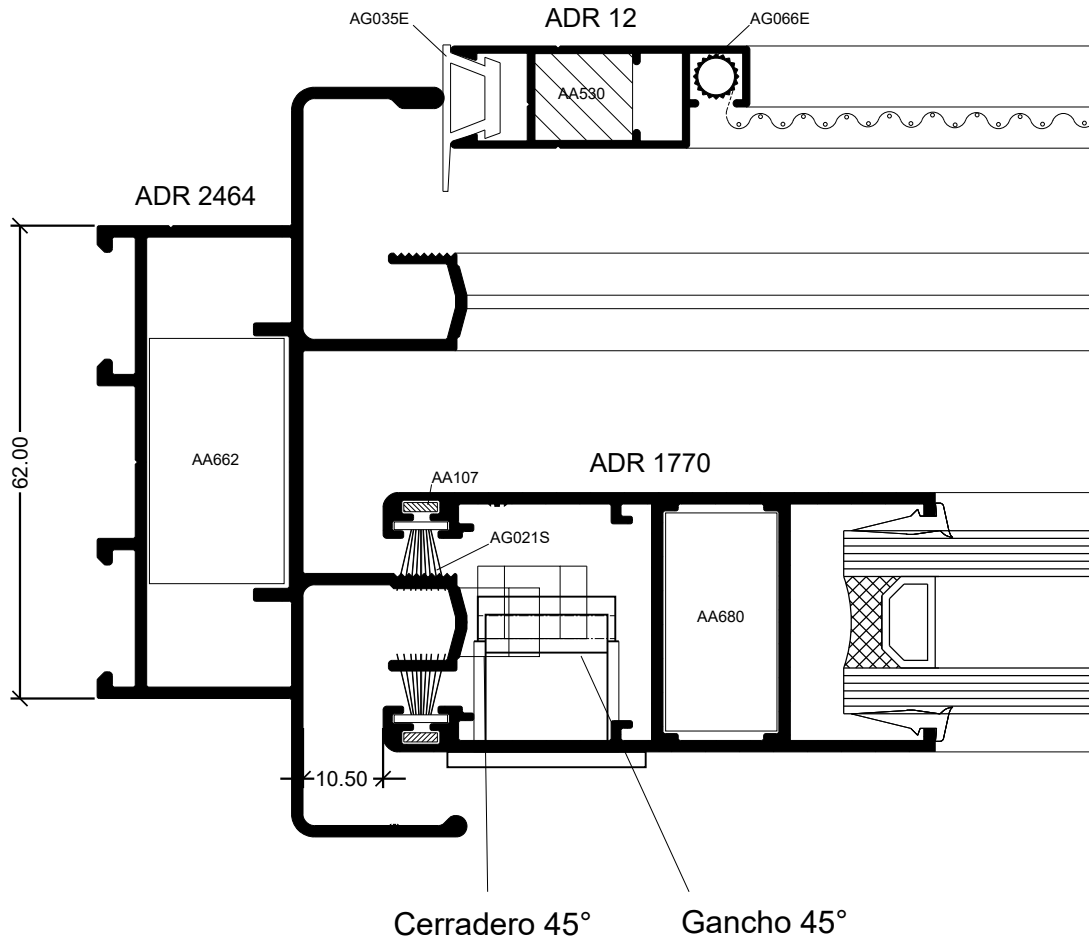

HA62 CORREDIZA

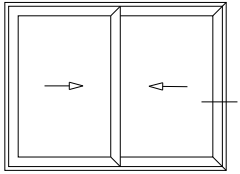

H54 PROIN ALUMINIO

Lateral Corrediza 2 hojas
Marco a 45° / Hoja a 90°

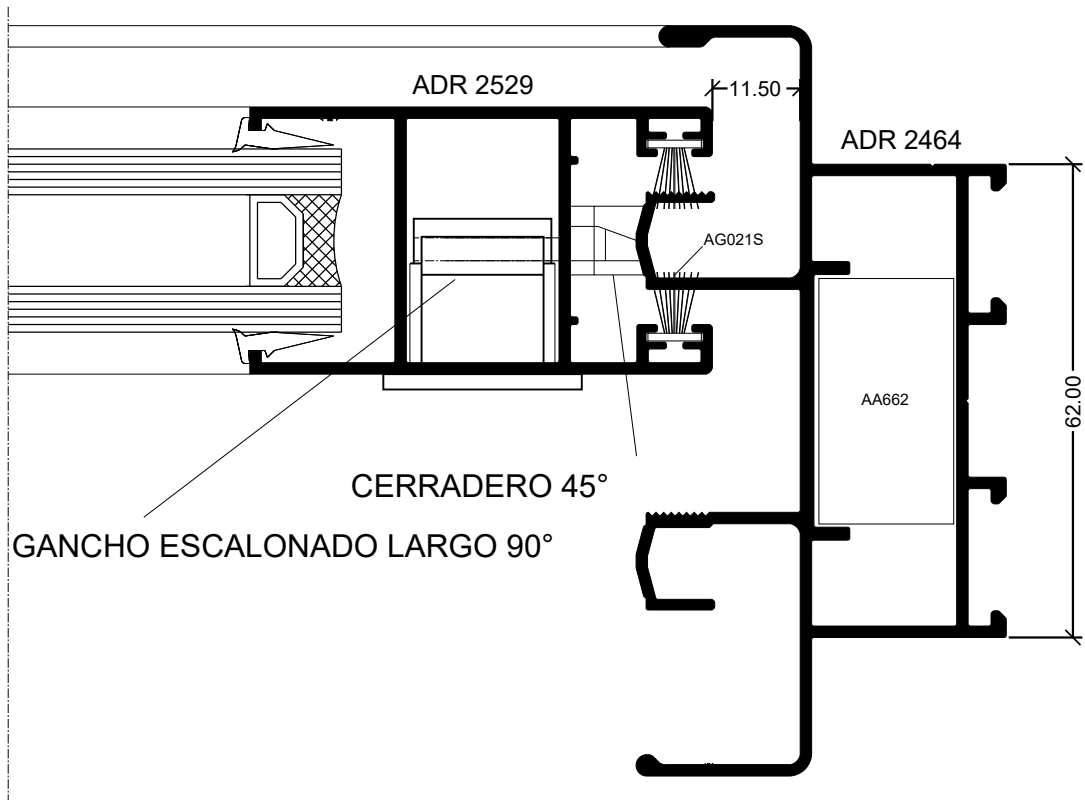

HA62 CORREDIZA

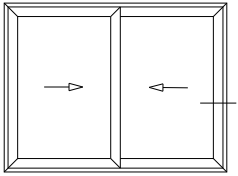

H56 CH - Clipar

Lateral Corrediza 2 hojas
Marco a 90° / Hoja a 90°

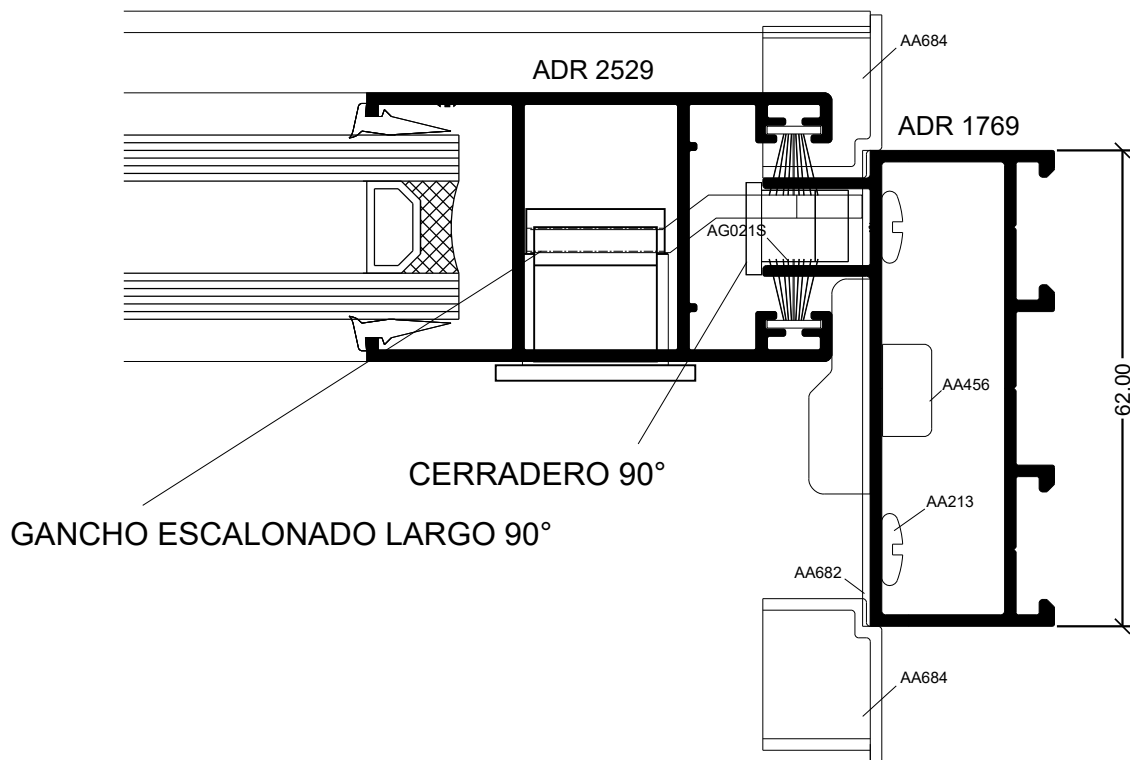

HA62 CORREDIZA



La Aldaba® Hydro

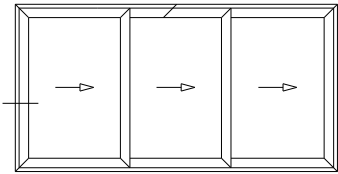

H56 CH - Clipar

Lateral Corrediza 2 hojas
Marco a 90° / Hoja a 45°

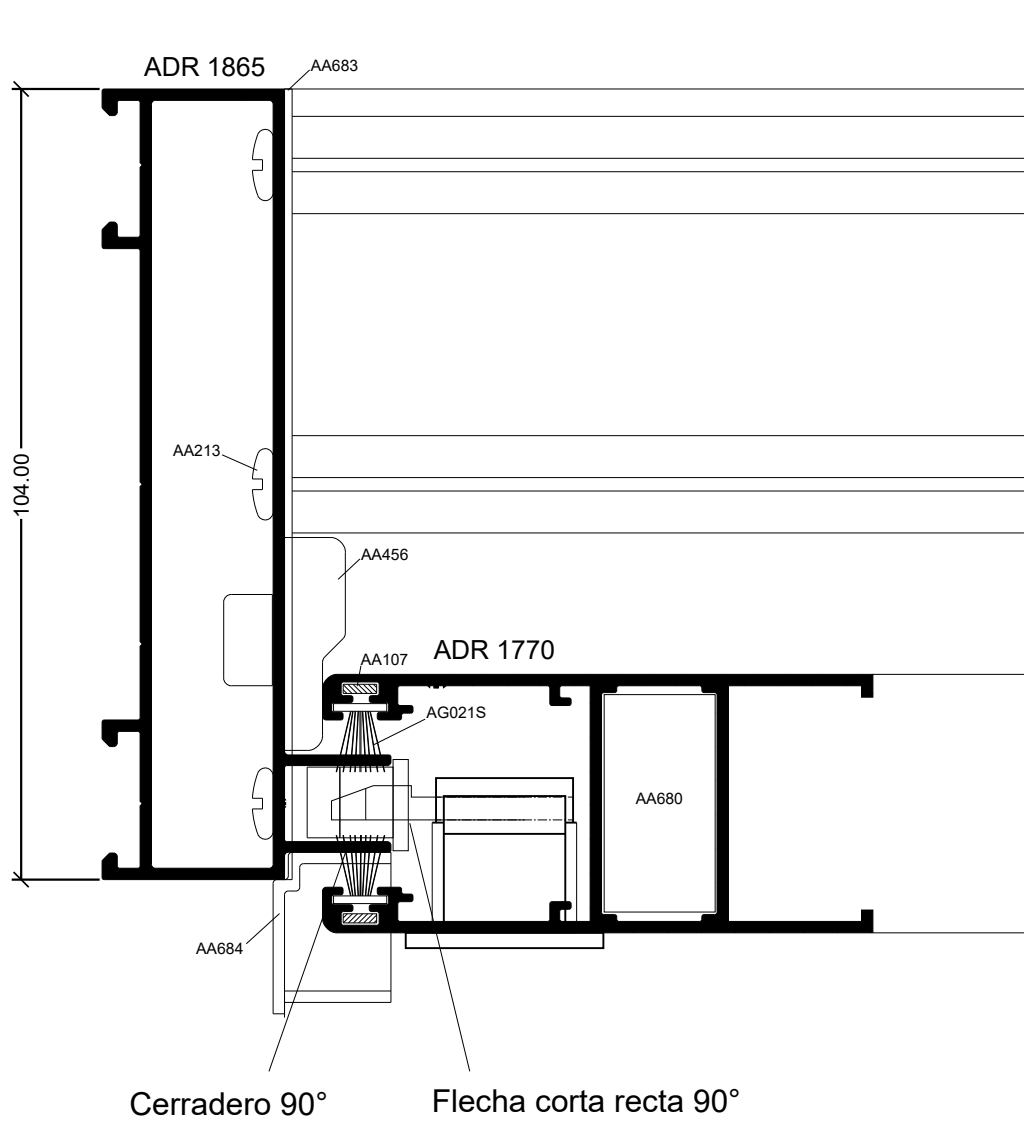

NÓRDICAL

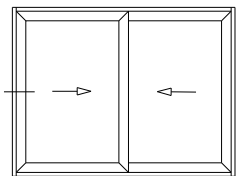

PROiN

La Aldaba

Hydro

H56 CH - Clipar

Lateral Corrediza 2 hojas
Marco a 90° / Hoja a 45°

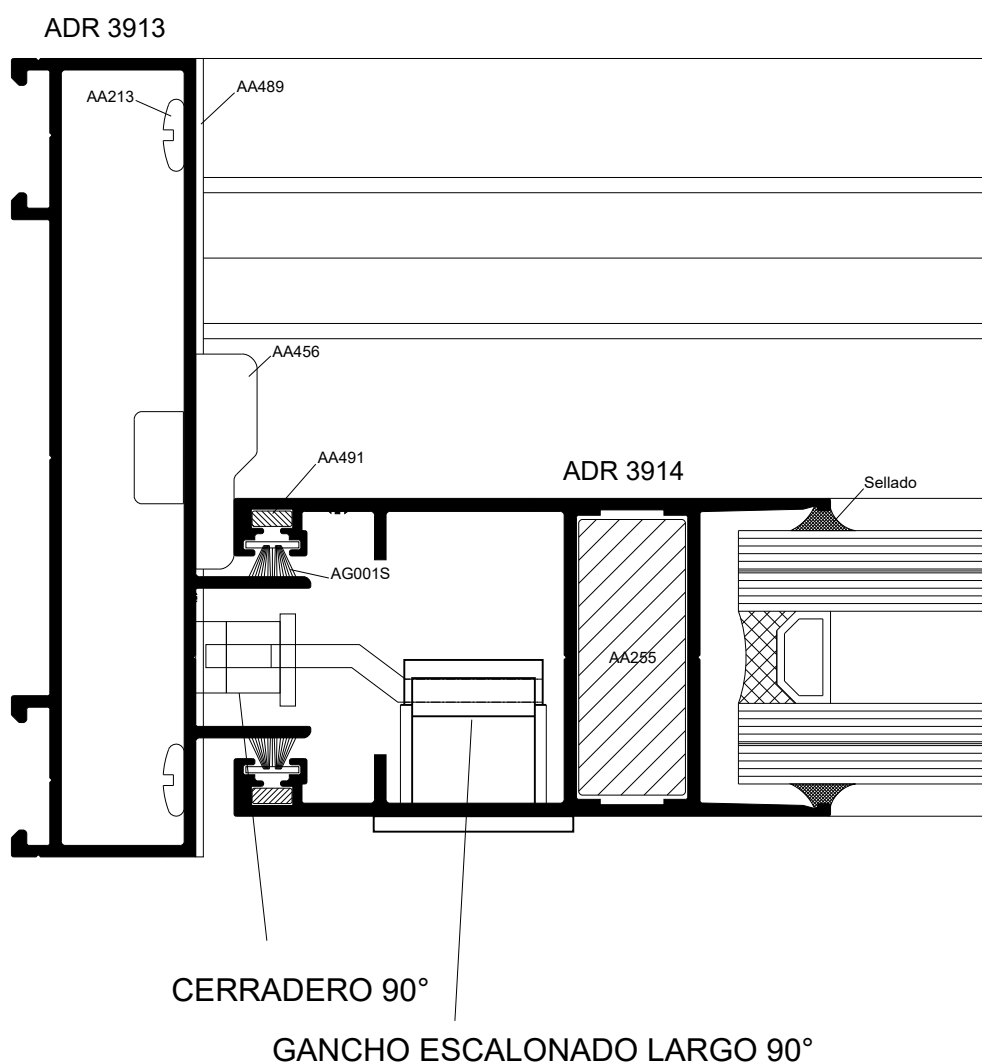

NÓRDICAL

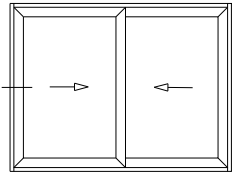

Lateral Izquierdo Corrediza 2 Hojas a 90°

H56 CH - Clipar

Lateral Corrediza 2 hojas
Marco a 90° / Hoja a 90°

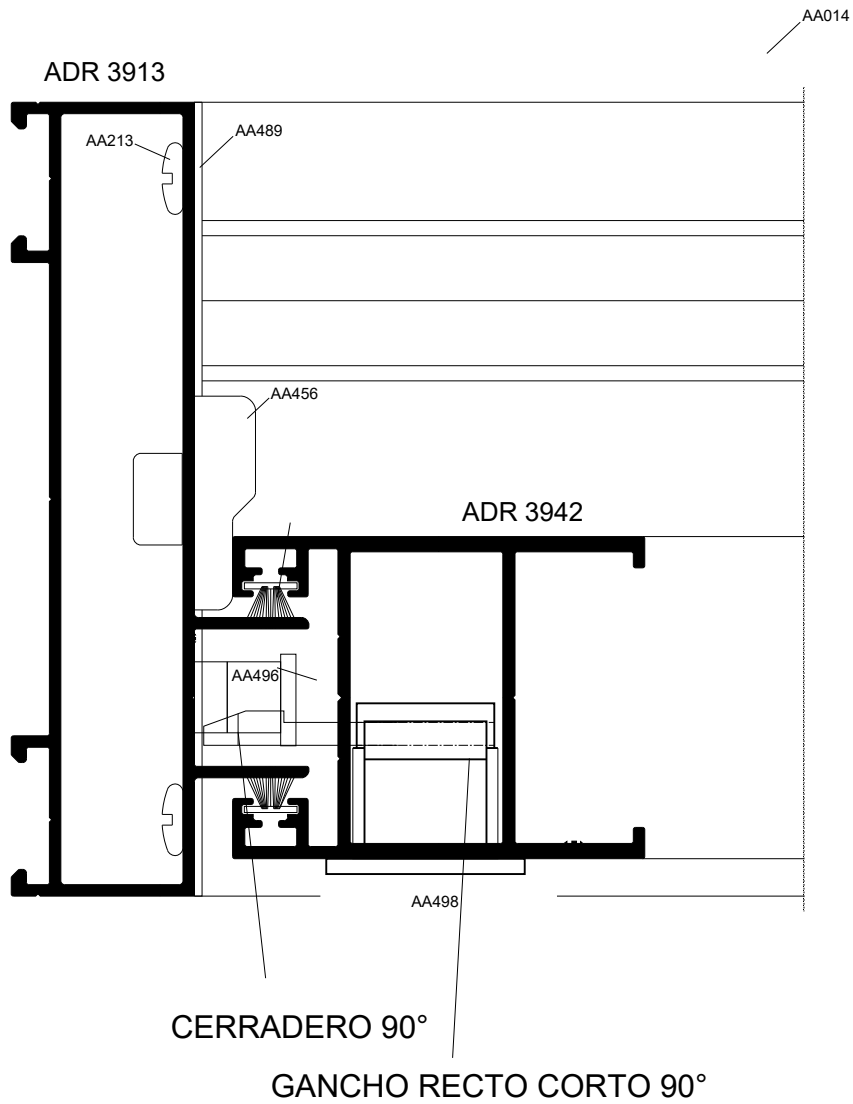

ORBITAL

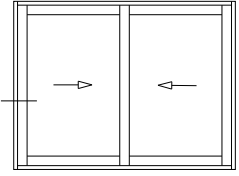

H56 CH - Clipar
Lateral Corrediza 2 hojas + mosquitero

Marco a 90° / Hoja a 90°

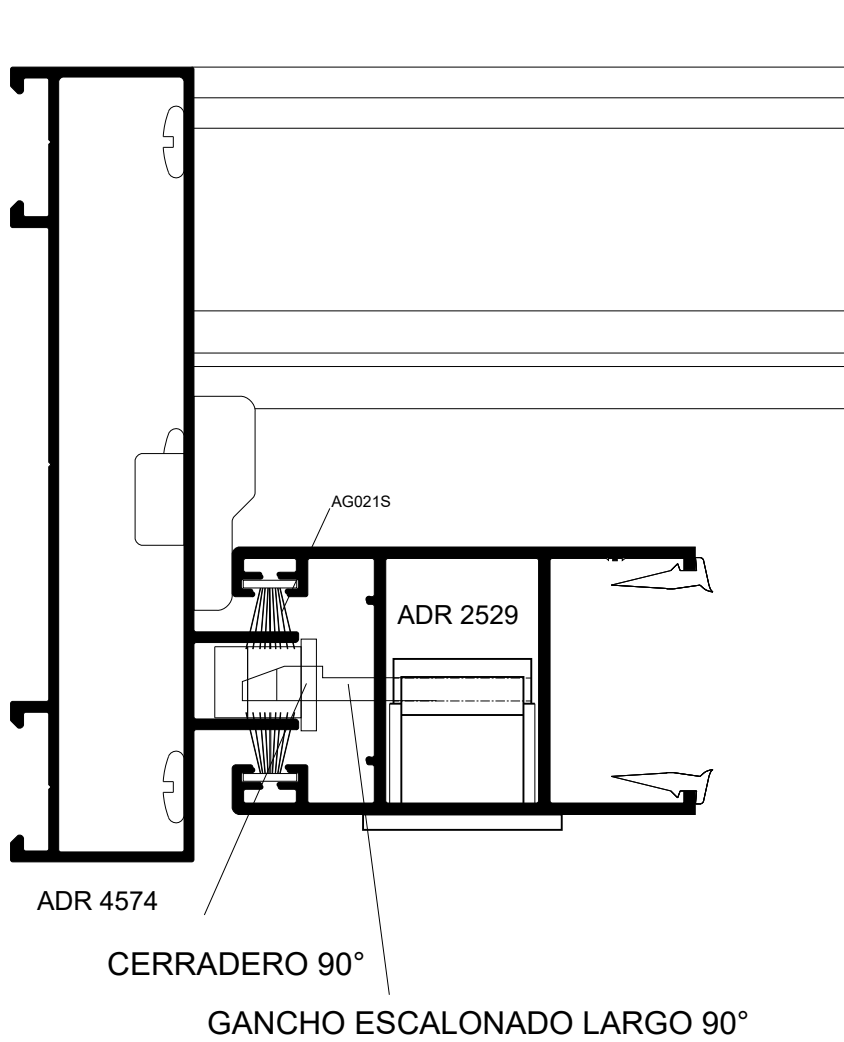

ORBITAL

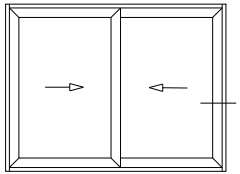

H56 CH - Clipar
Lateral Corrediza 2 hojas + mosquitero

Marco a 90° / Hoja a 45°

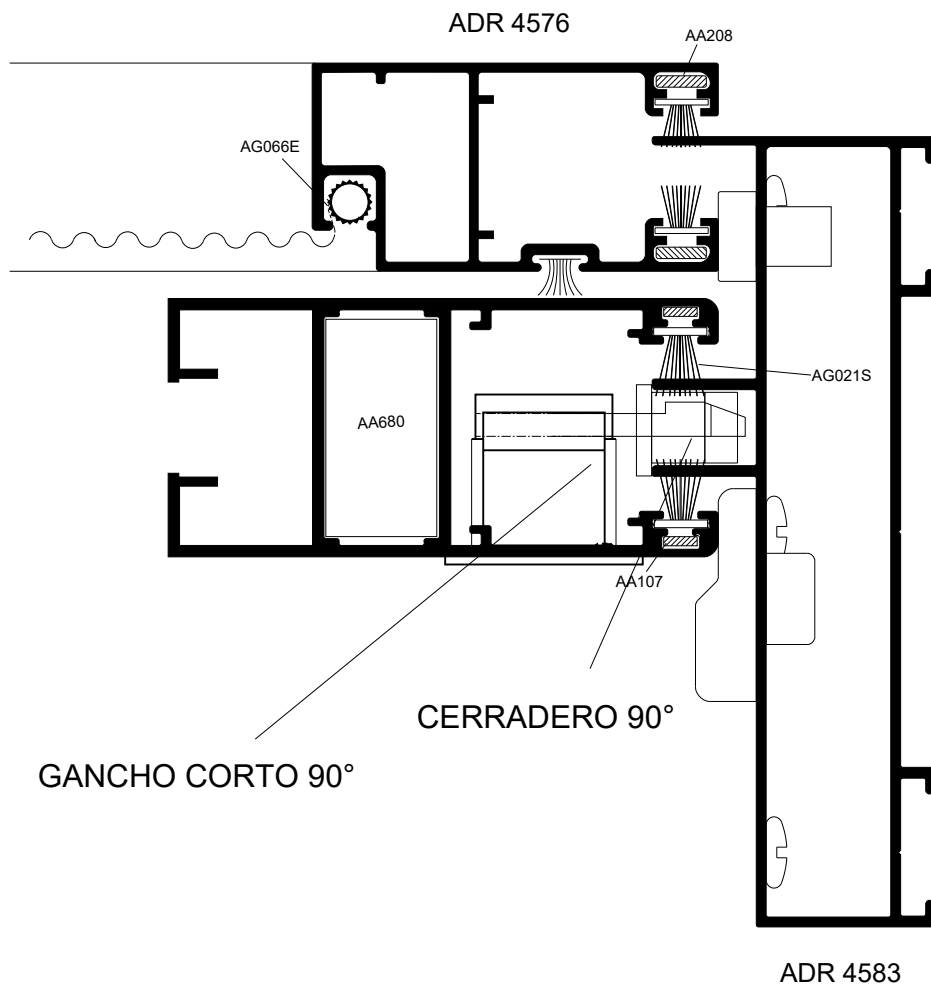

ORBITAL

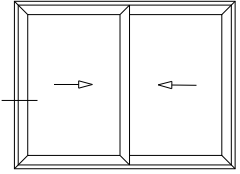

H56 CH - Clipar

Lateral Corrediza 2 hojas + mosquitero

Marco a 45° / Hoja 45°

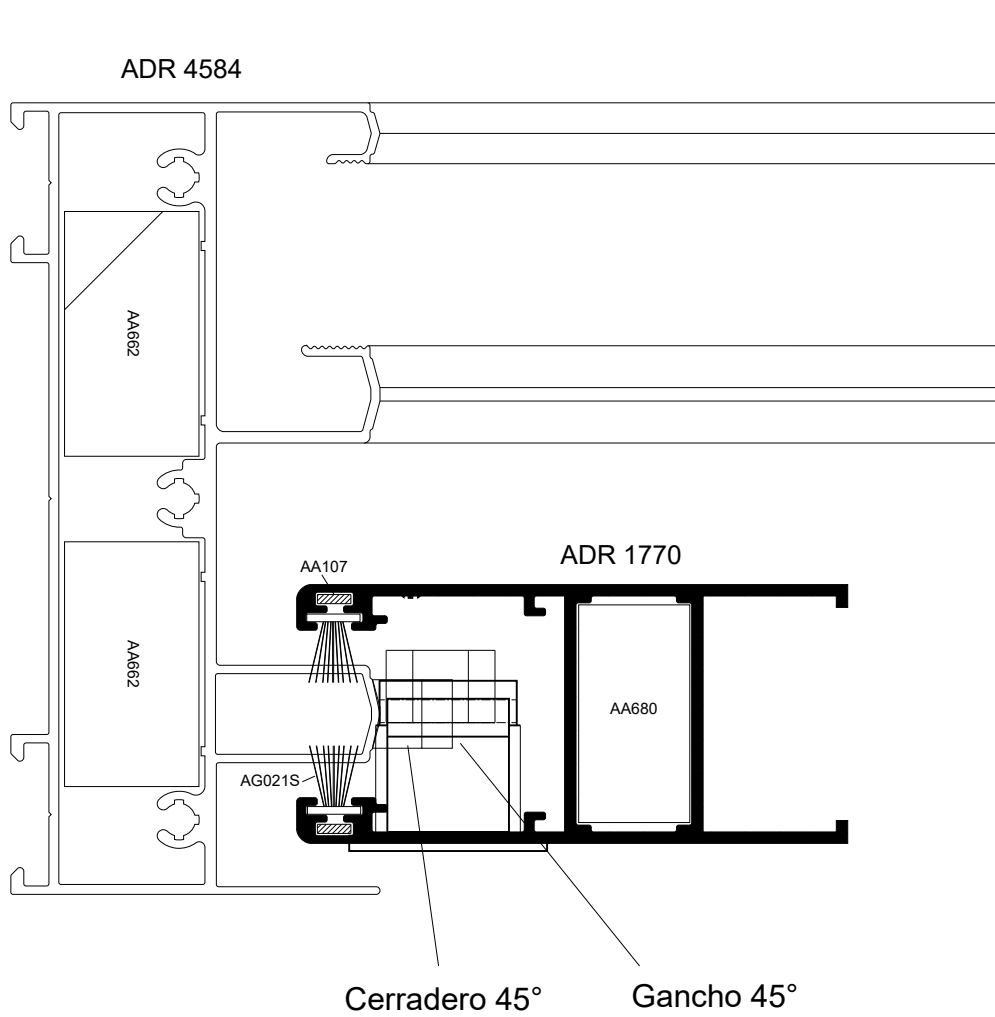

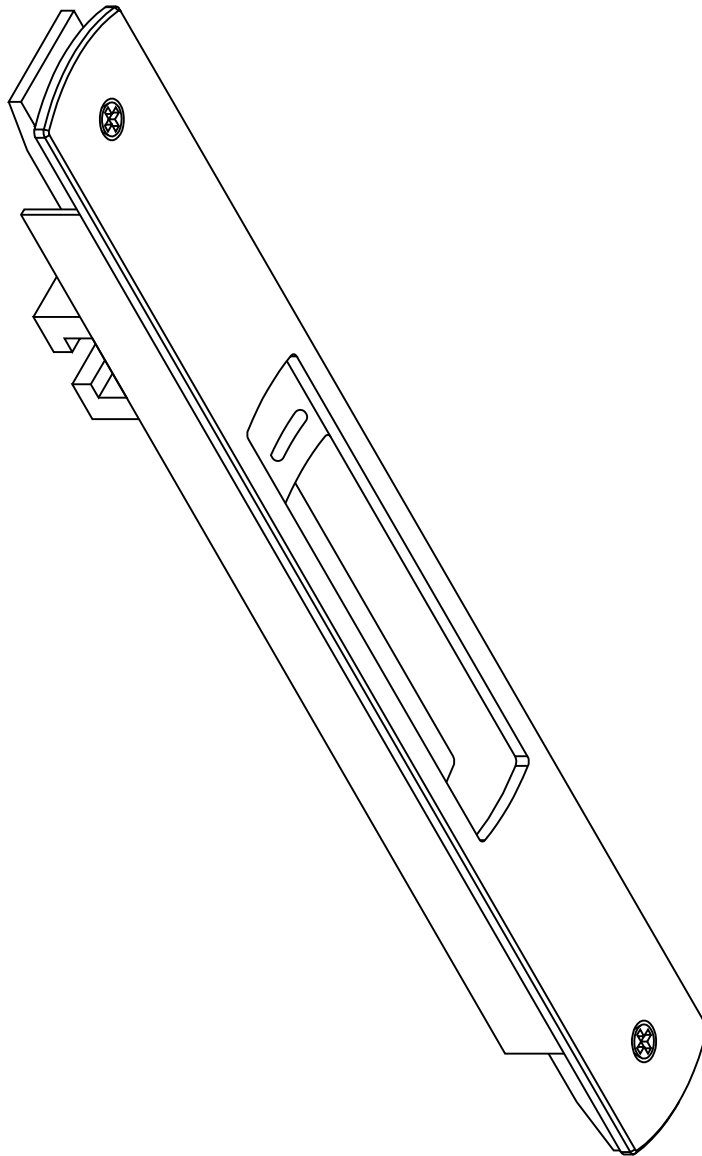

H56 - 1615 PROIN
Escala 1:1

HA62 CORREDIZA

PROiN

La Aldaba

Hydro

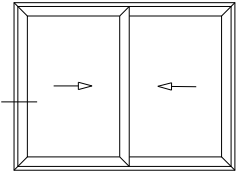

H56 - 1615 PROIN

Lateral Corrediza 2 hojas
Marco a 45° / Hoja a 45°

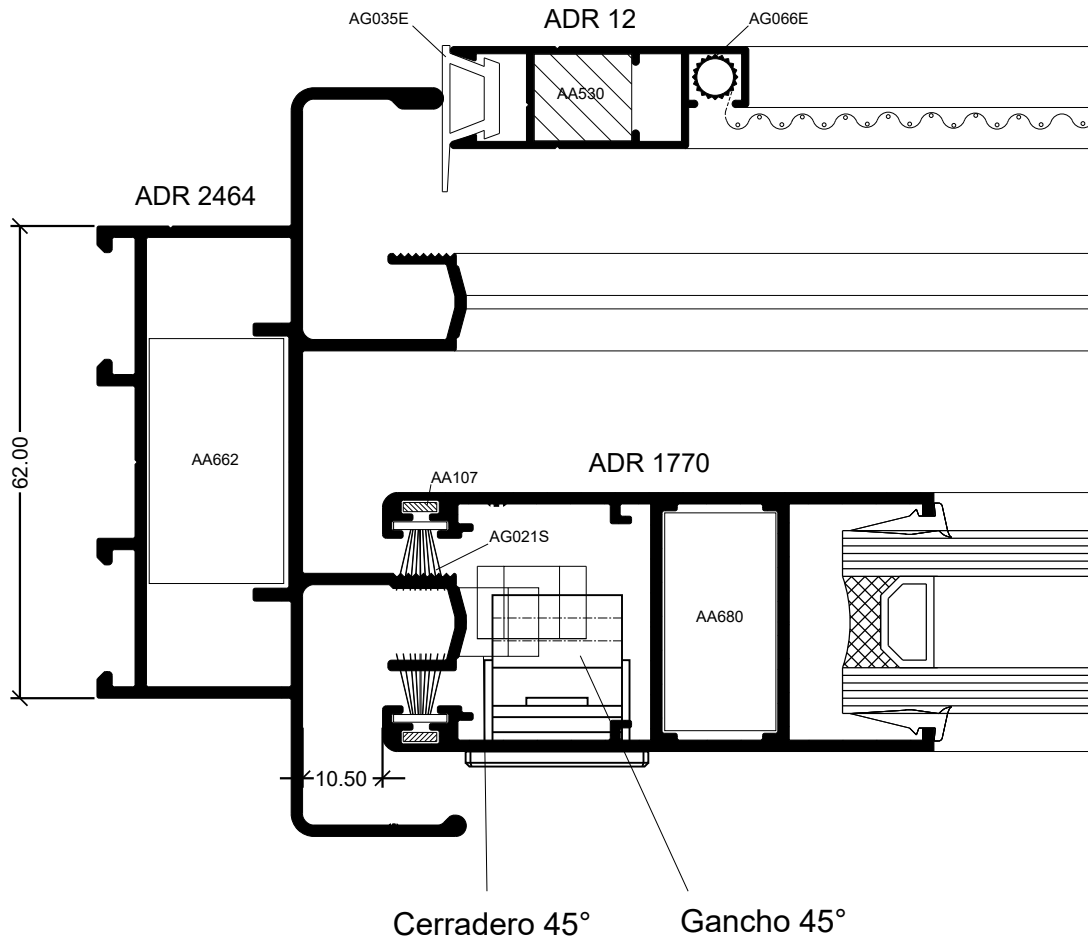

HA62 CORREDIZA

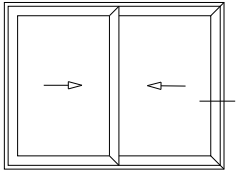

H56 - 1615 PROIN

Lateral Corrediza 2 hojas
Marco a 45° / Hoja a 90°

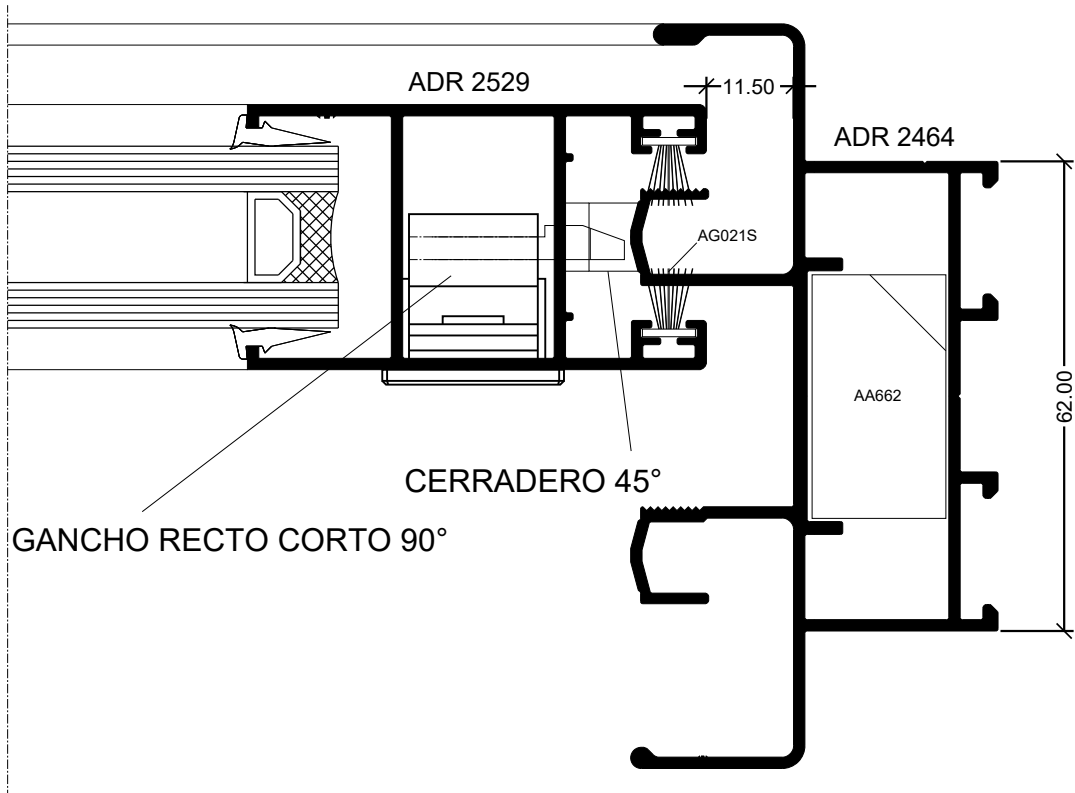

HA62 CORREDIZA

PROiN



La Aldaba

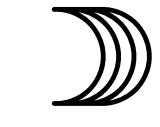

Hydro

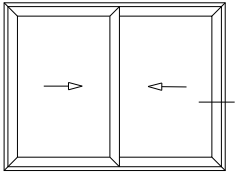

H56 - 1615 PROIN

Lateral Corrediza 2 hojas
Marco a 90° / Hoja a 90°

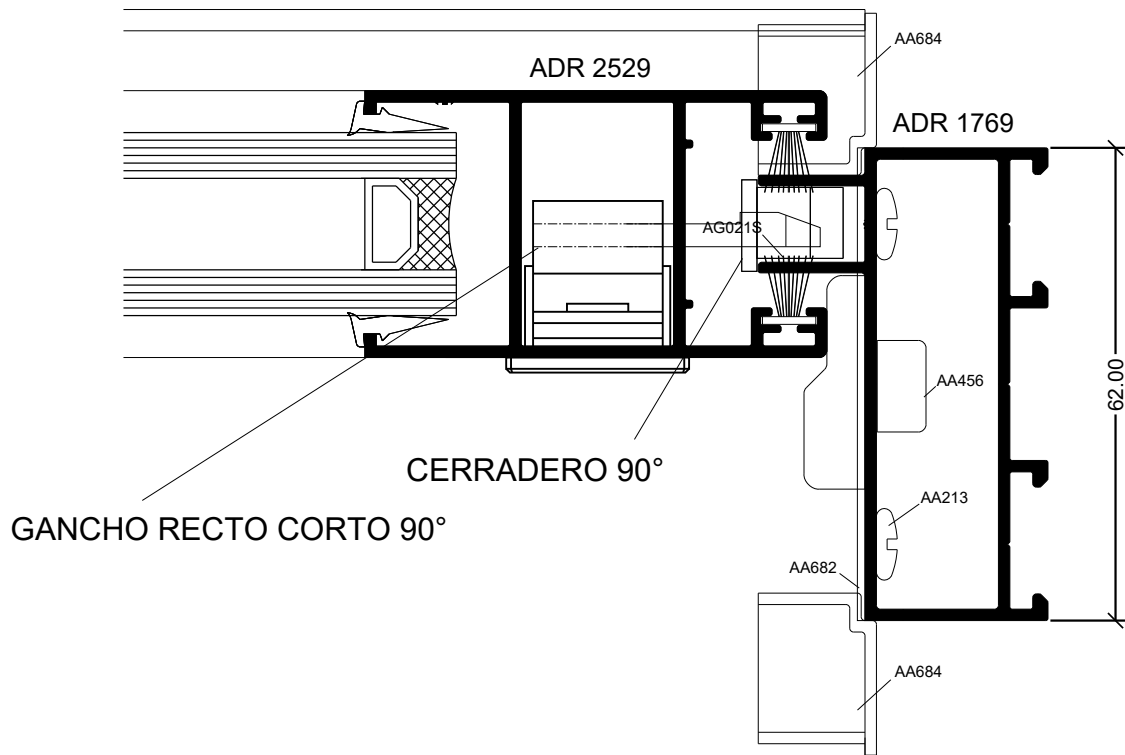

HA62 CORREDIZA

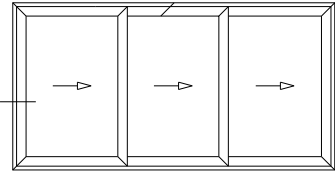

H56 - 1615 PROIN

Lateral Corrediza 2 hojas
Marco a 90° / Hoja a 45°

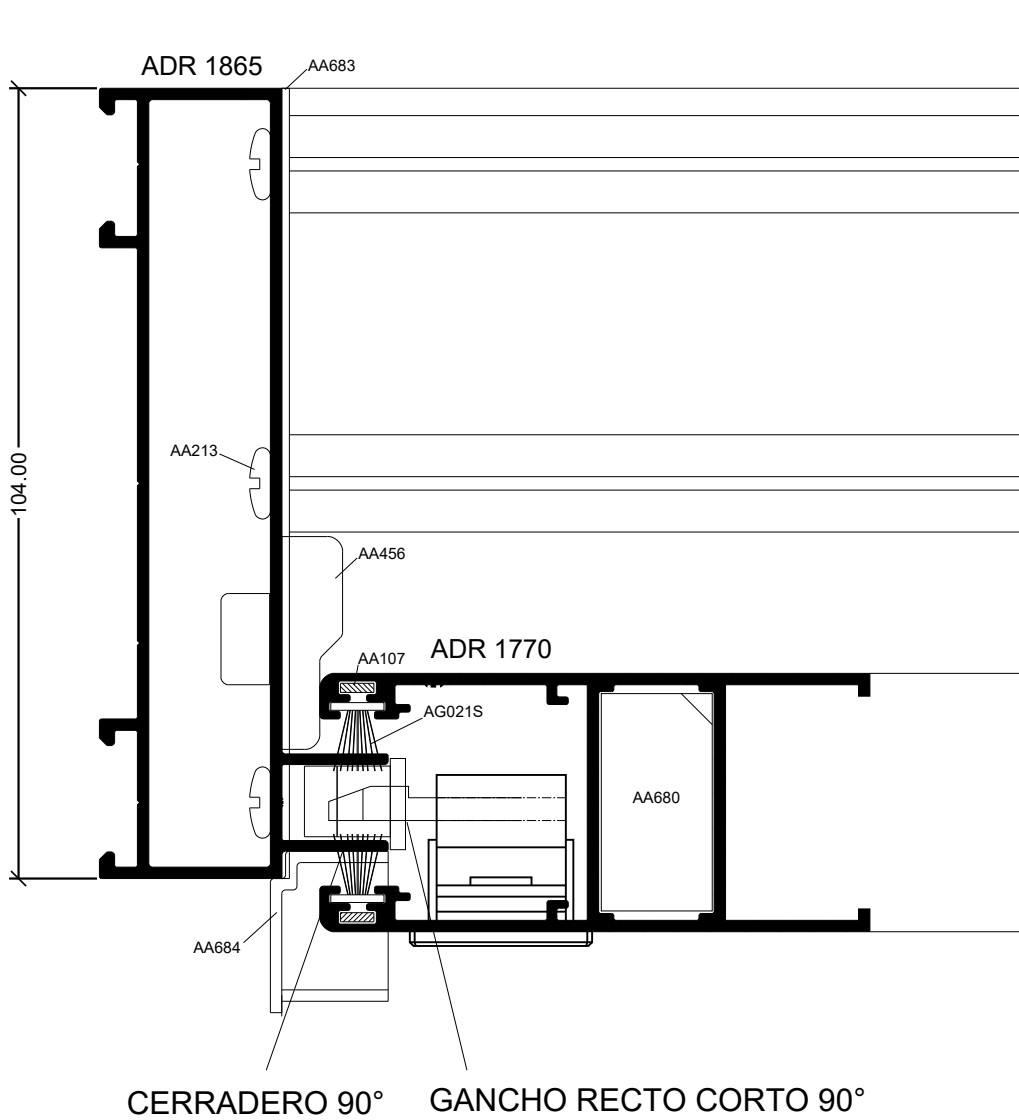

NÓRDICAL

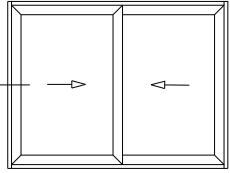

H54 H56 - 1615 PROINALUMINIO

Lateral Corrediza 2 hojas
Marco a 90° / Hoja a 45°

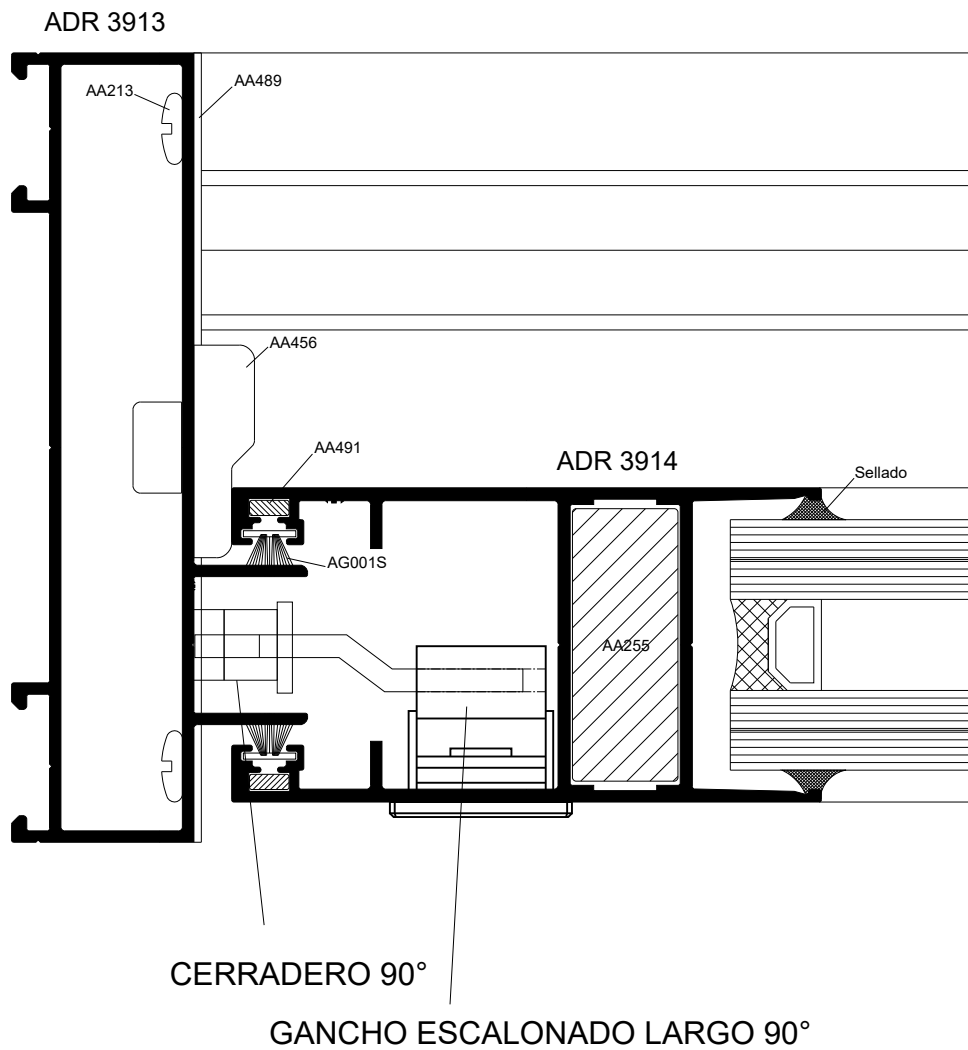

NÓRDICAL

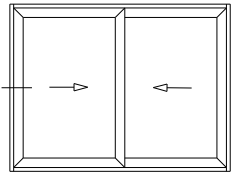

Lateral Izquierdo Corrediza 2 Hojas a 90°

H56 - 1615 PROIN

Lateral Corrediza 2 hojas
Marco a 90° / Hoja a 90°

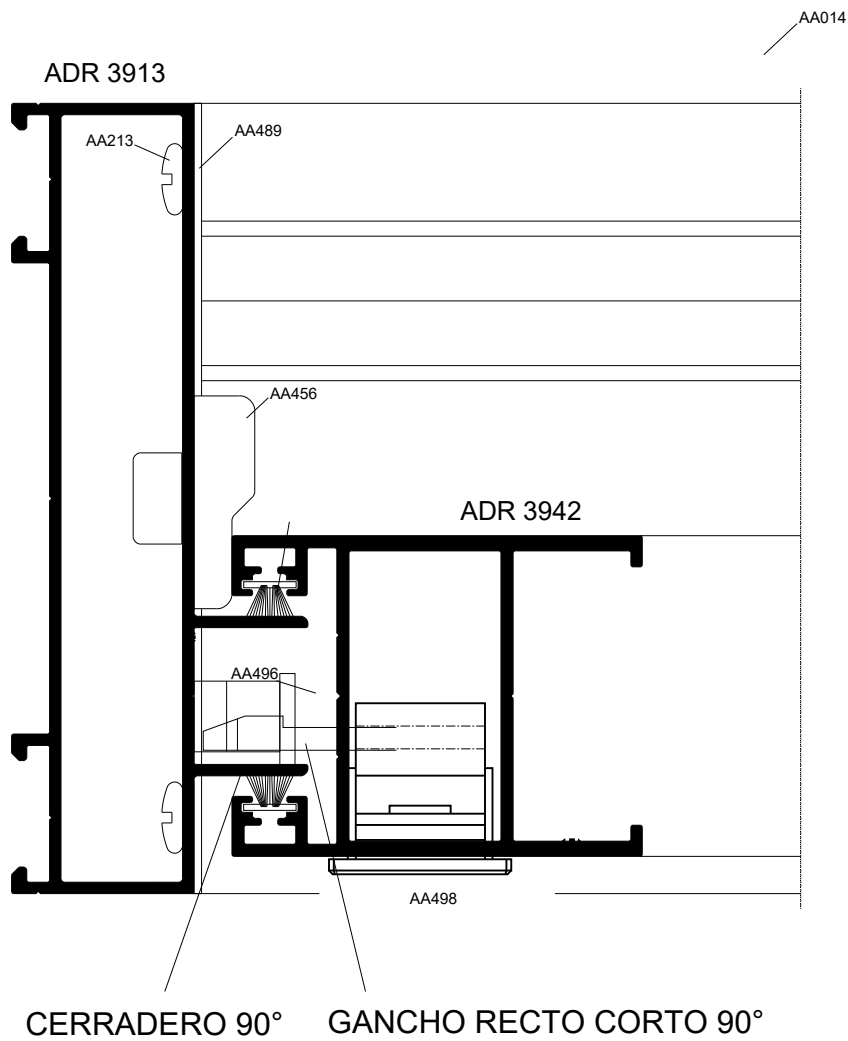

ORBITAL

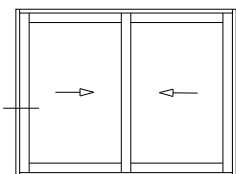

PROiN



La Aldaba



Hydro

H56 - 1615 PROIN

Lateral Corrediza 2 hojas + mosquitero

Marco a 90° / Hoja a 90°

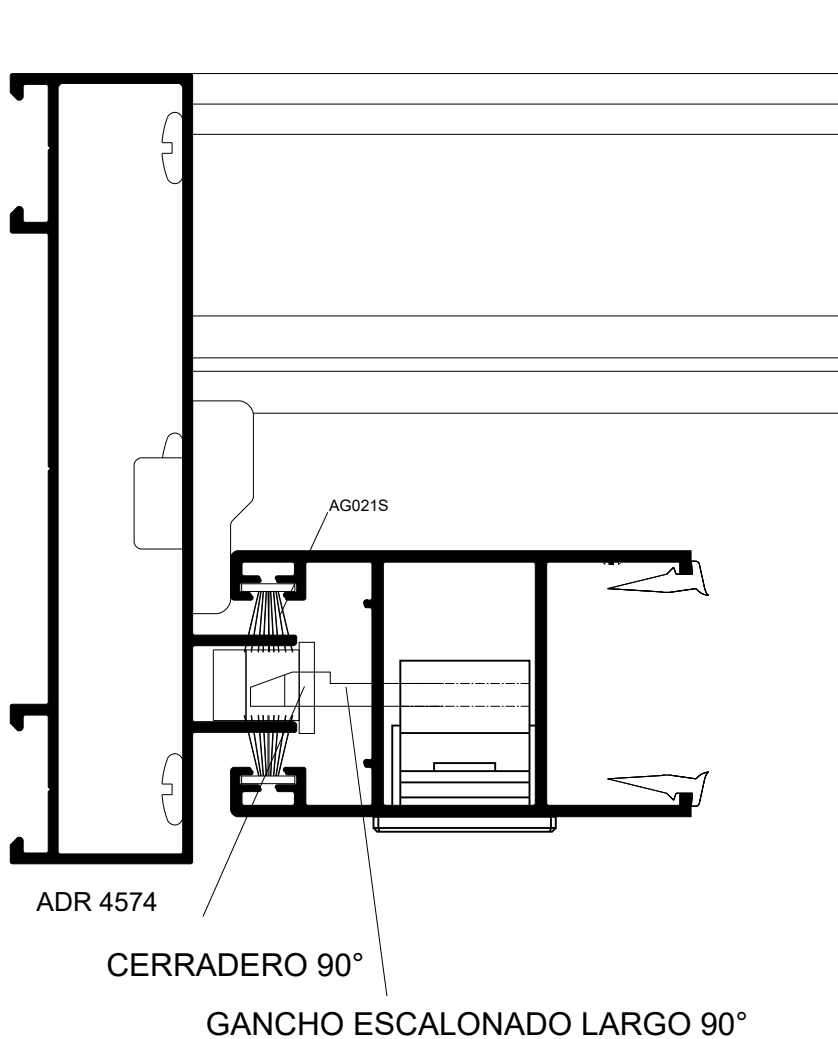

ORBITAL

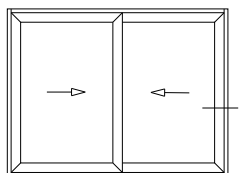

H56 - 1615 PROIN

Lateral Corrediza 2 hojas + mosquitero

Marco a 90° / Hoja a 45°

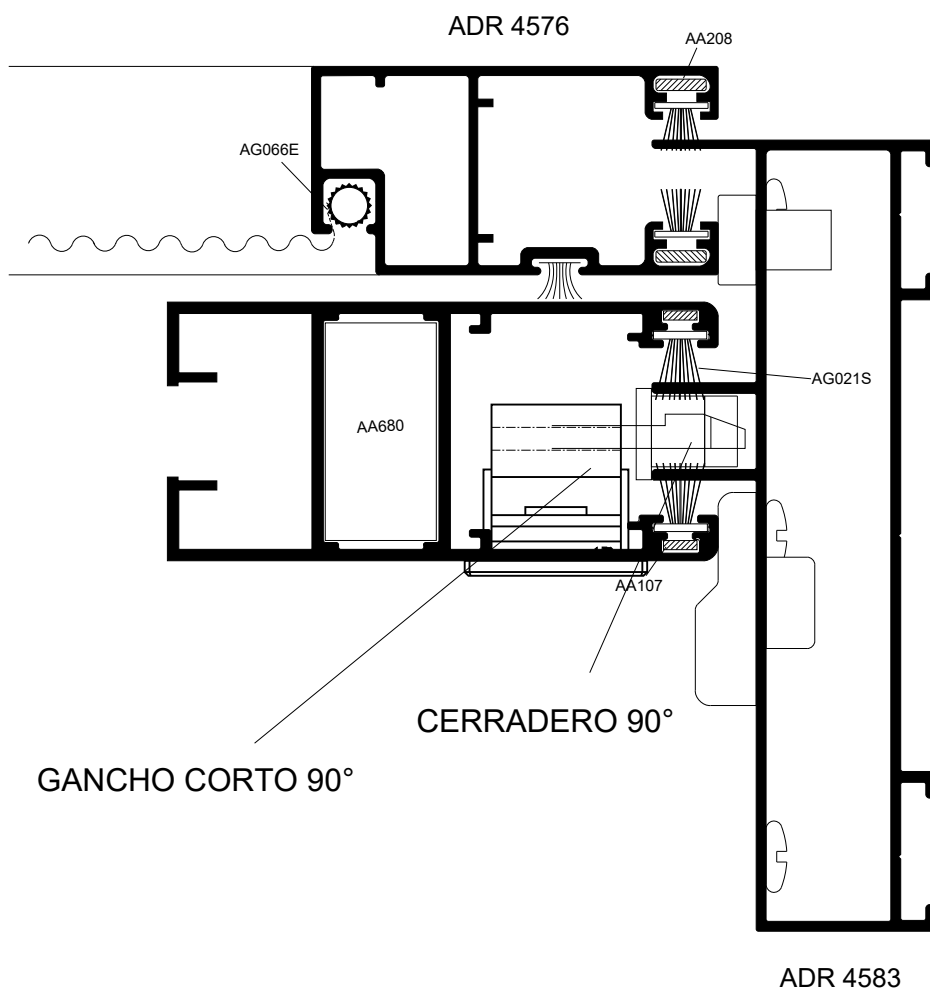

ORBITAL

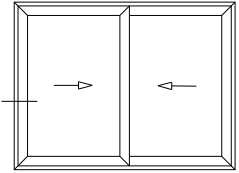

PROiN



La Aldaba



Hydro

H56 - 1615 PROIN

Lateral Corrediza 2 hojas + mosquitero

Marco a 45° / Hoja 45°

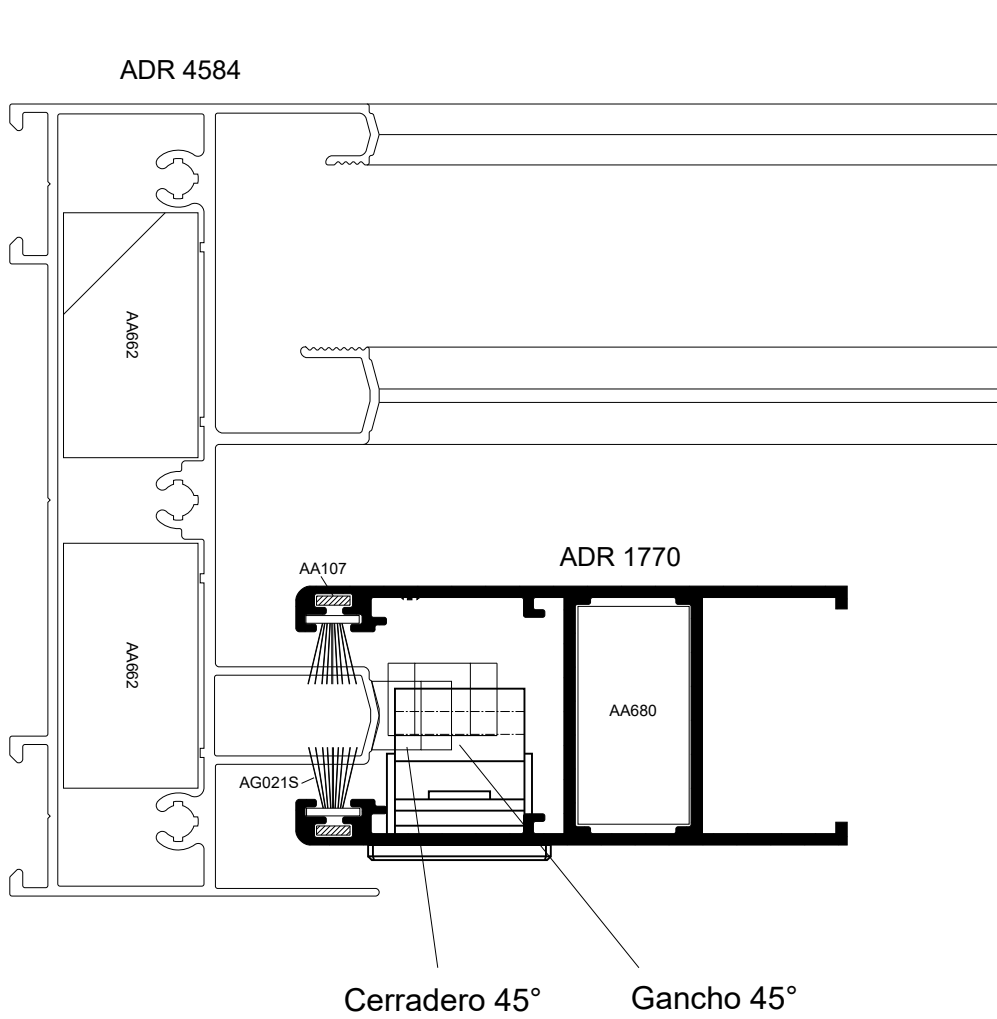

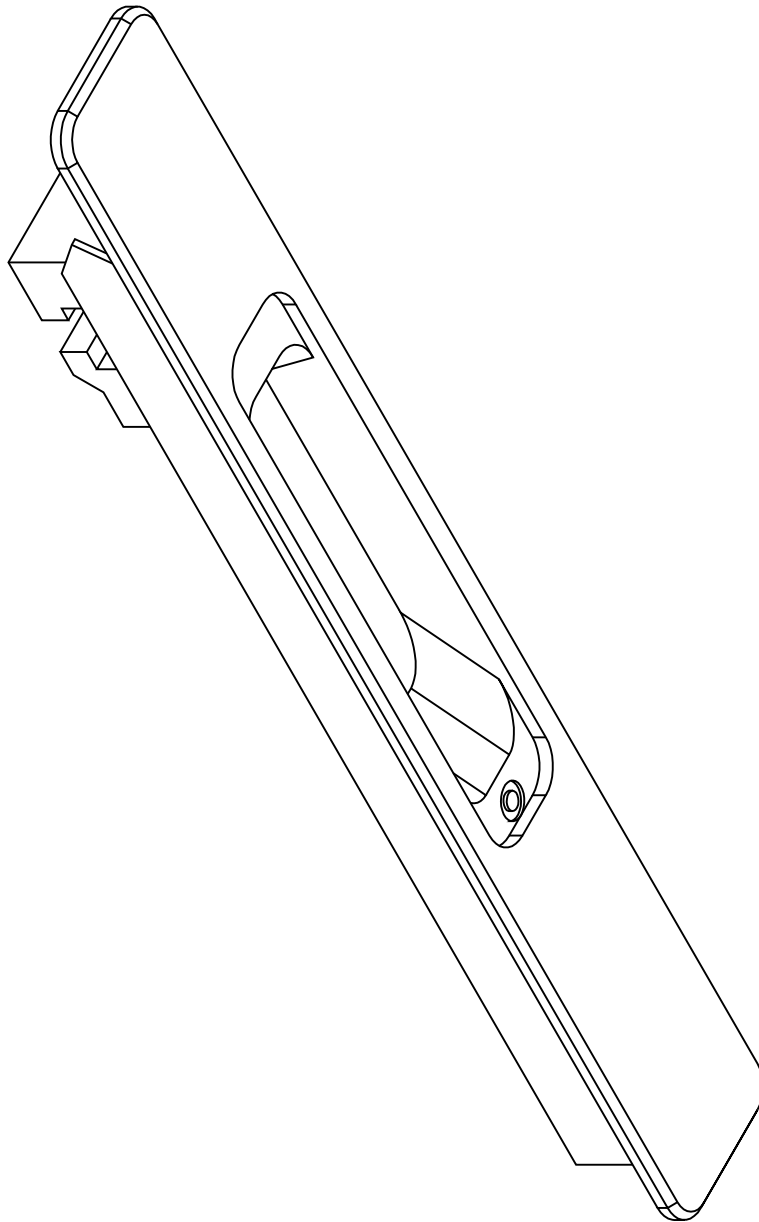

H56 DOPPIO PROIN
Escala 1:1

HA62 CORREDIZA

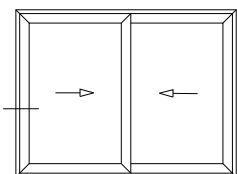

H56 DOPPIO PROIN

Lateral Corrediza 2 hojas
Marco a 45° / Hoja a 45°

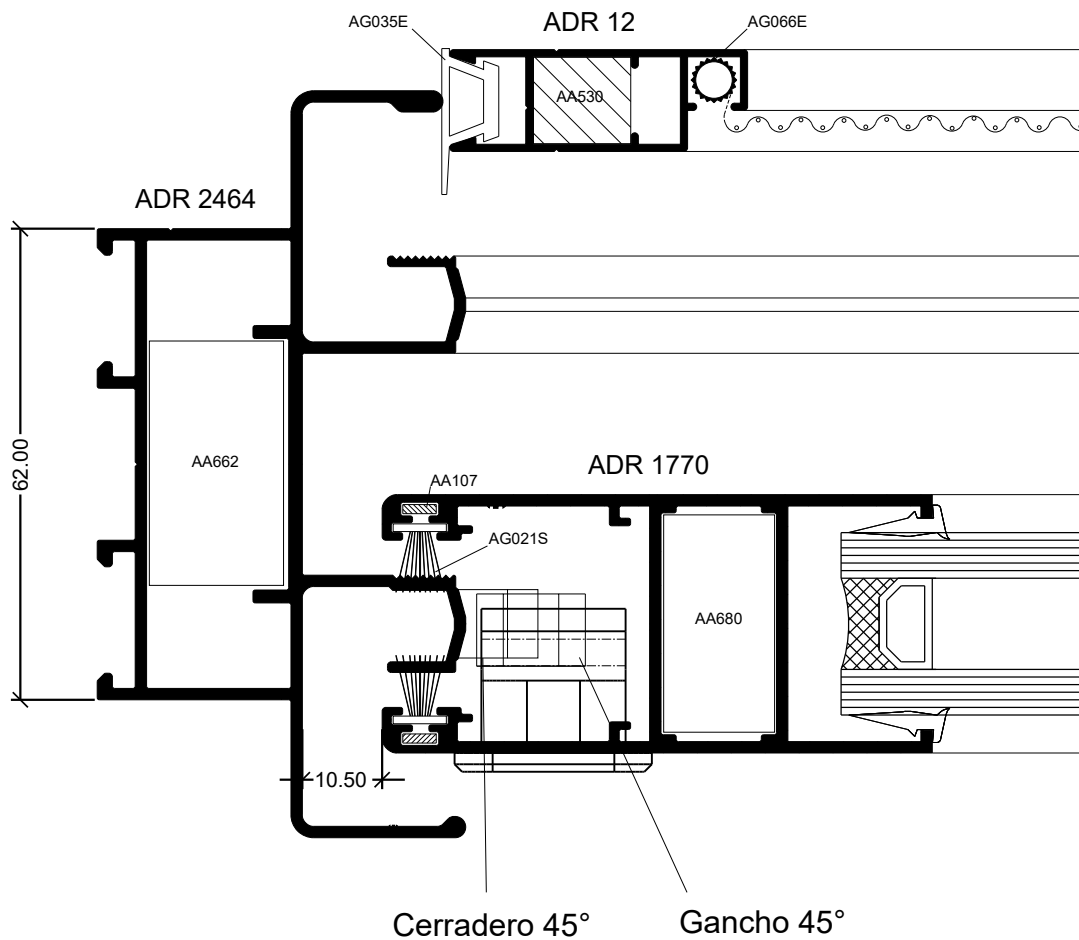

HA62 CORREDIZA

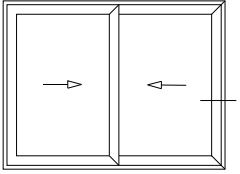

H56 DOPPIO PROIN

Lateral Corrediza 2 hojas
Marco a 45° / Hoja a 90°

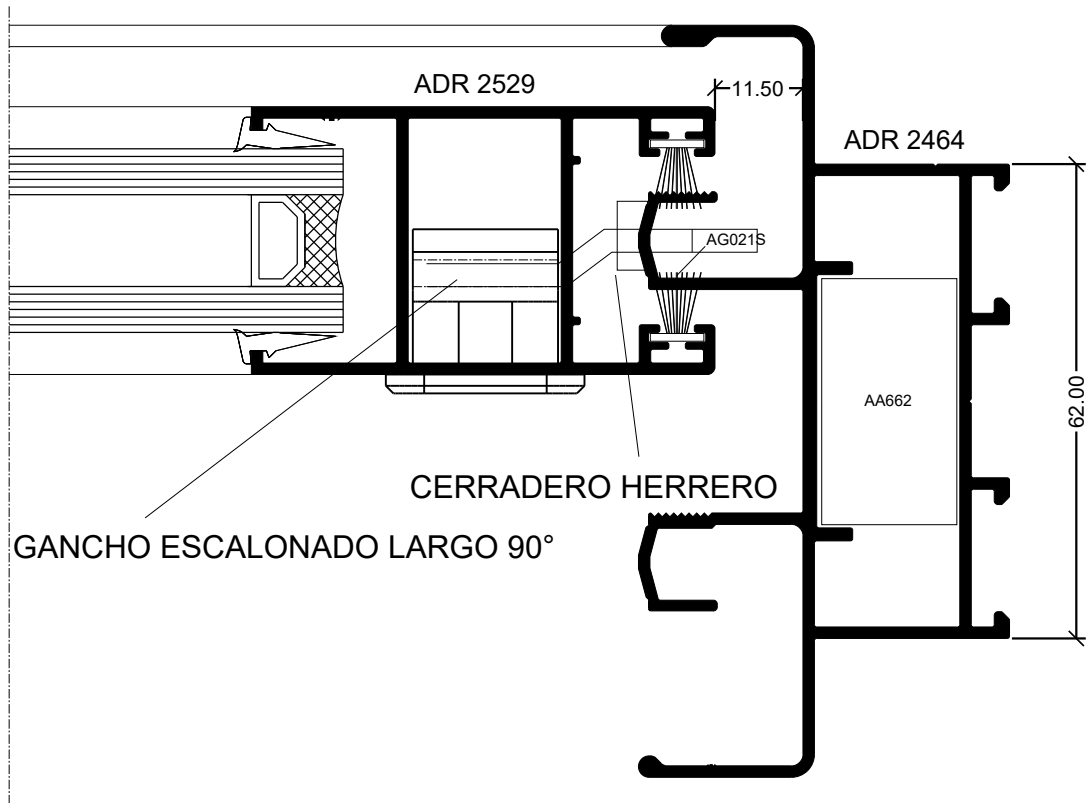

NÓRDICAL

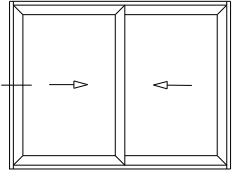

PROiN

La Aldaba

Hydro

H56 DOPPIO PROIN

Lateral Corrediza 2 hojas
Marco a 90° / Hoja a 45°

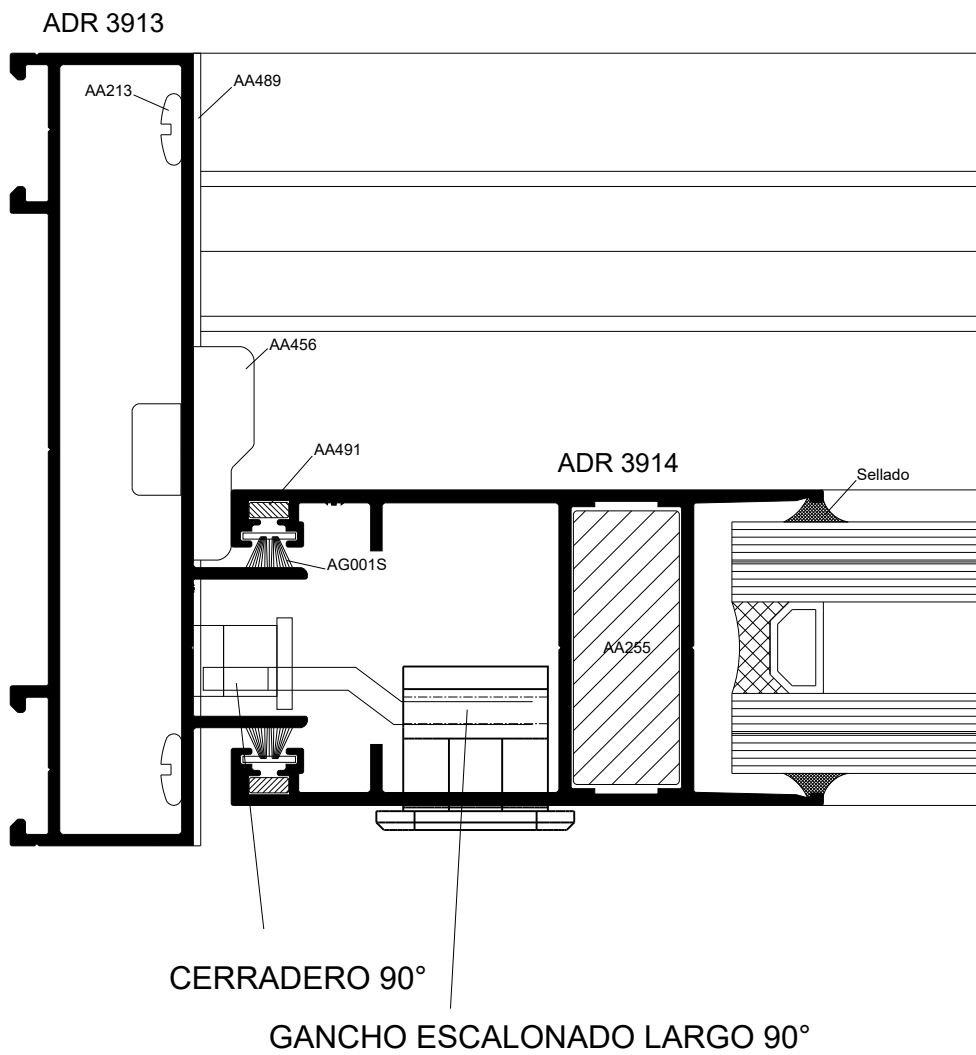

NÓRDICAL

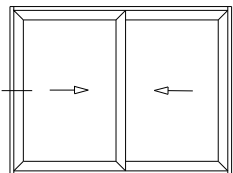

Lateral Izquierdo Corrediza 2 Hojas a 90°

H56 DOPPIO PROIN

Lateral Corrediza 2 hojas
Marco a 90° / Hoja a 90°

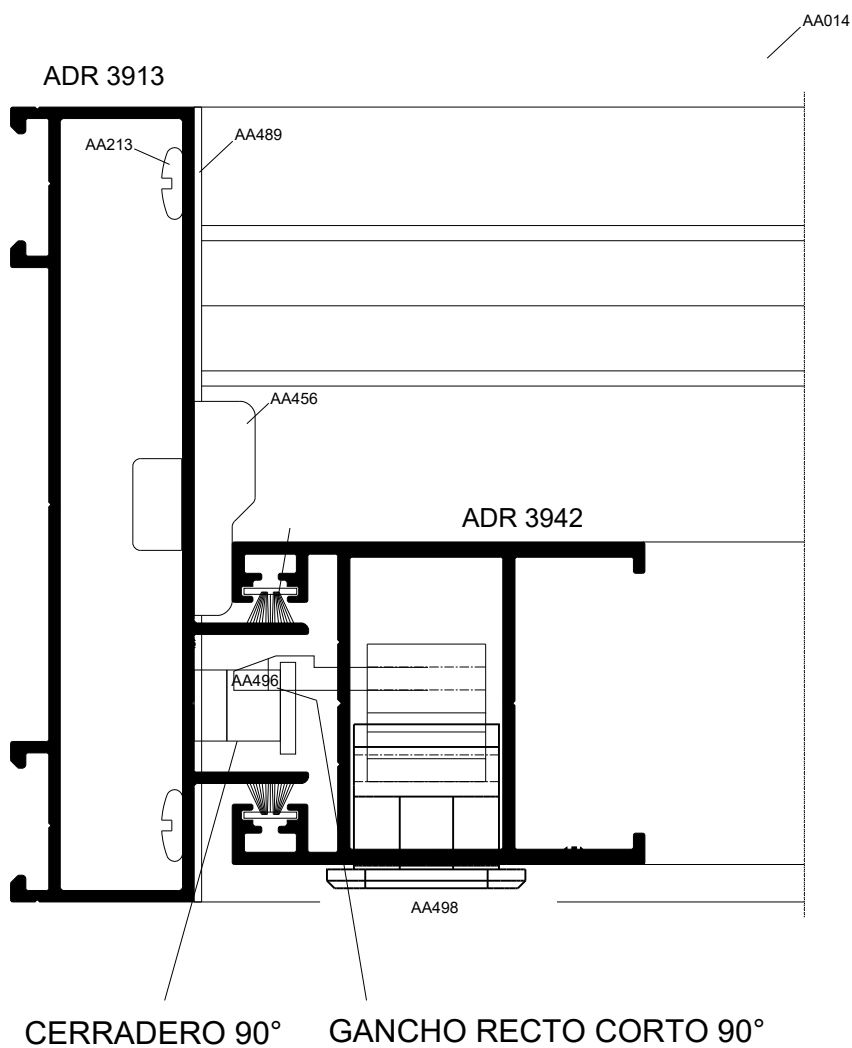

ORBITAL

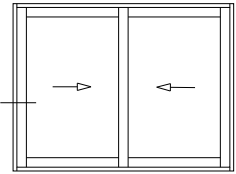

H56 DOPPIO PROIN

Lateral Corrediza 2 hojas + mosquitero

Marco a 90° / Hoja a 90°

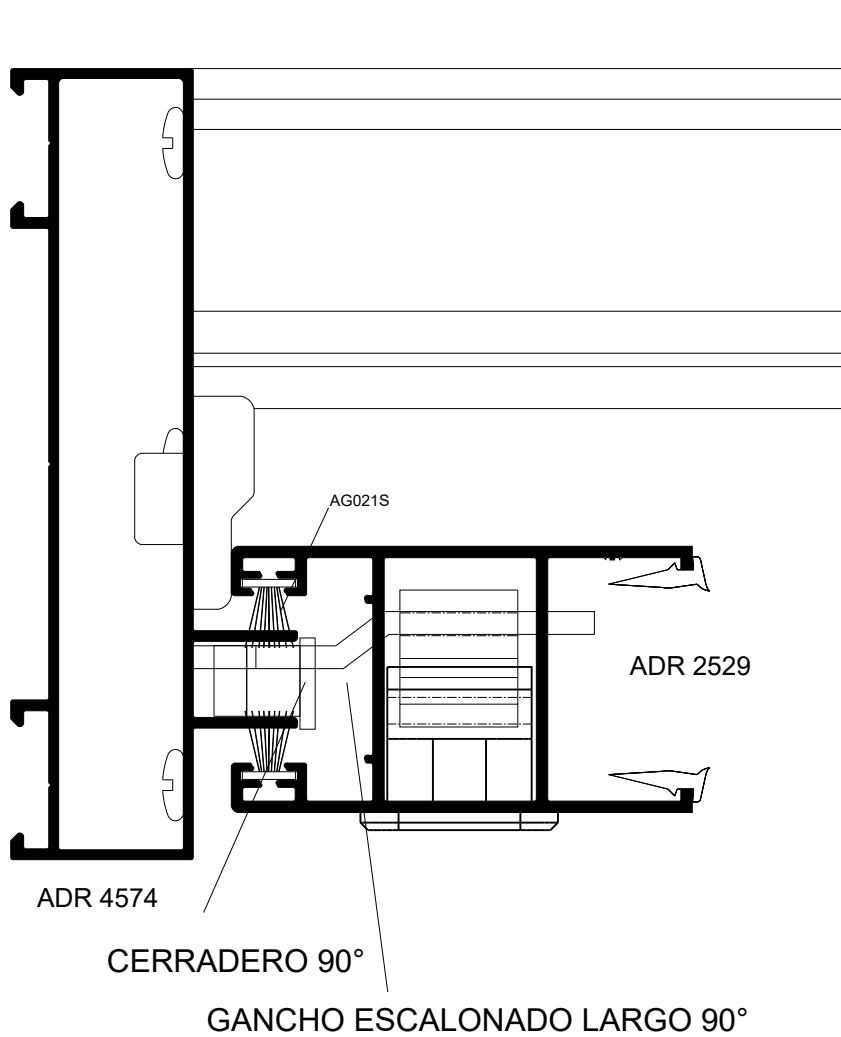

ORBITAL

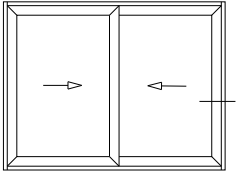

PROiN



La Aldaba



Hydro

H56 DOPPIO PROIN

Lateral Corrediza 2 hojas + mosquitero

Marco a 90° / Hoja a 45°

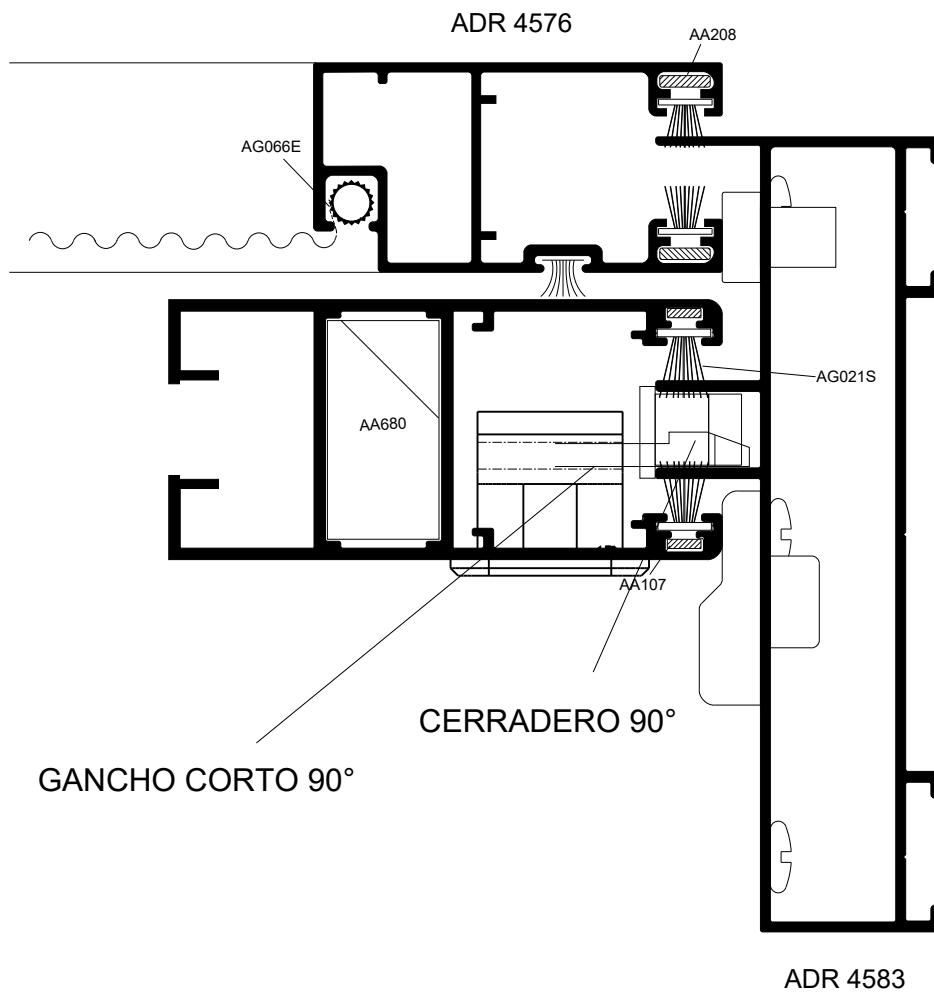

ORBITAL

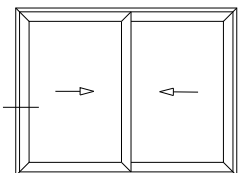

H56 DOPPIO PROIN

Lateral Corrediza 2 hojas + mosquitero

Marco a 45° / Hoja 45°

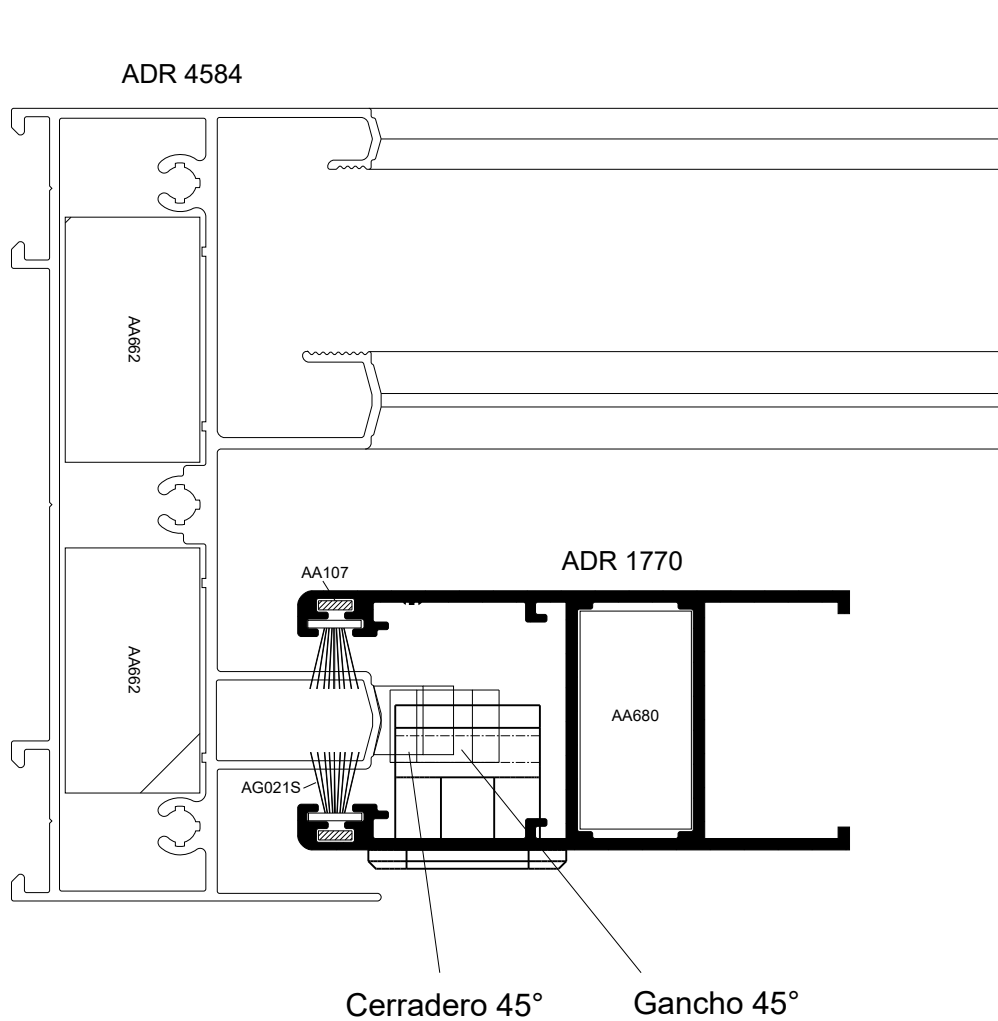

2200

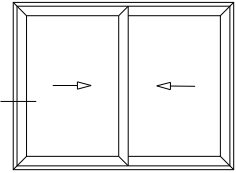

H56 DOPPIO PROIN

H56 DOPPIO PROIN

Lateral Corrediza 2 hojas + mosquitero

Marco a 90° / Hoja 90°

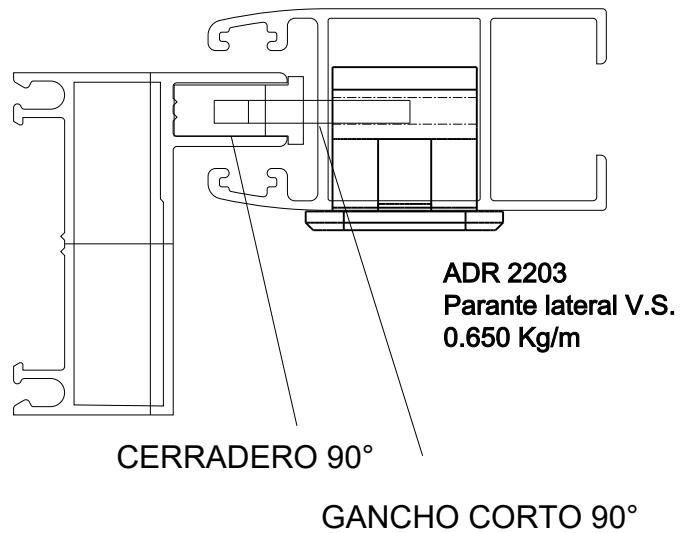

H56 DOPPIO PROIN Escala 1:1

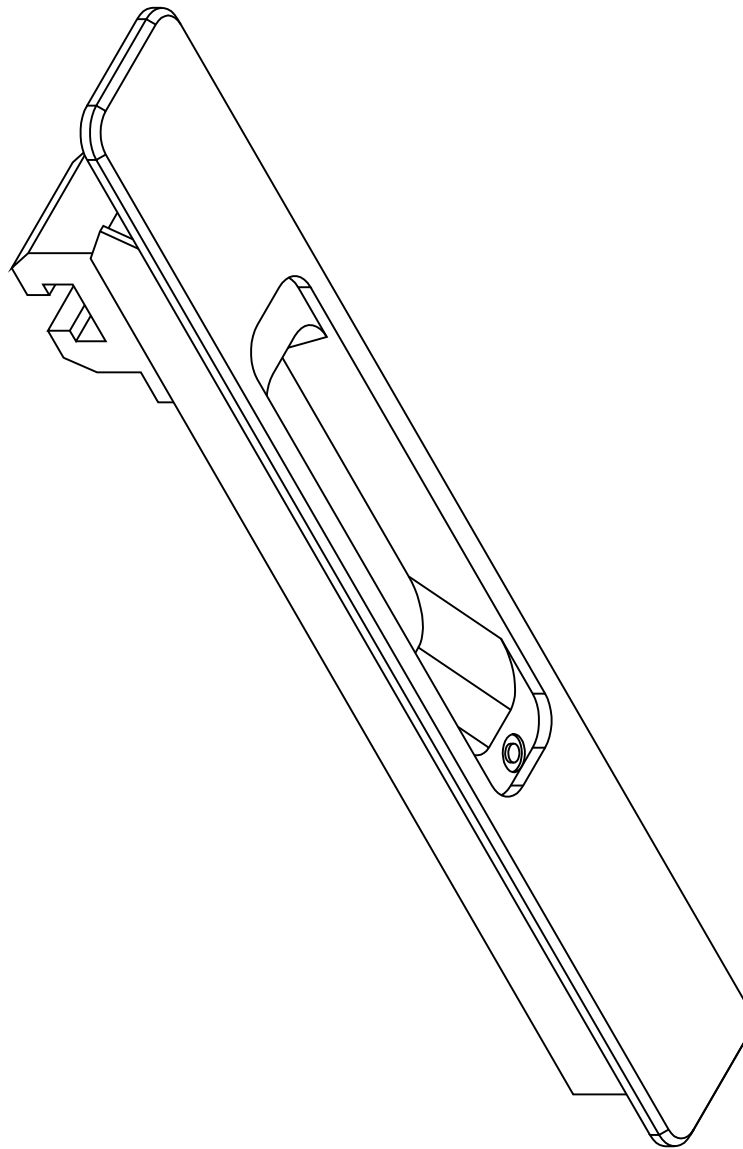

H56 DOPPIO - H101
Escala 1:1

HA62 CORREDIZA

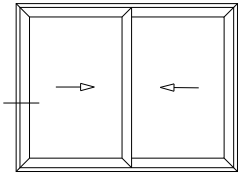

H56 DOPPIO - H101

Lateral Corrediza 2 hojas
Marco a 90° / Hoja a 45°

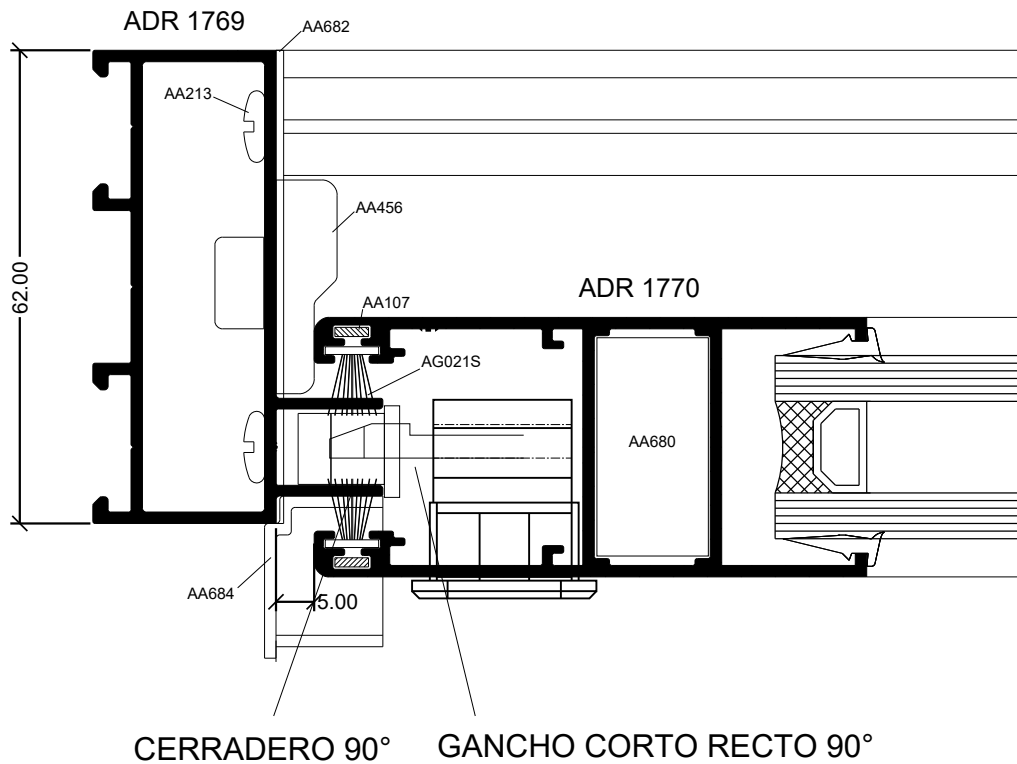

HA62 CORREDIZA

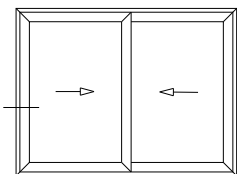

H56 DOPPIO - H101

Lateral Corrediza 2 hojas
Marco a 45° / Hoja a 45°

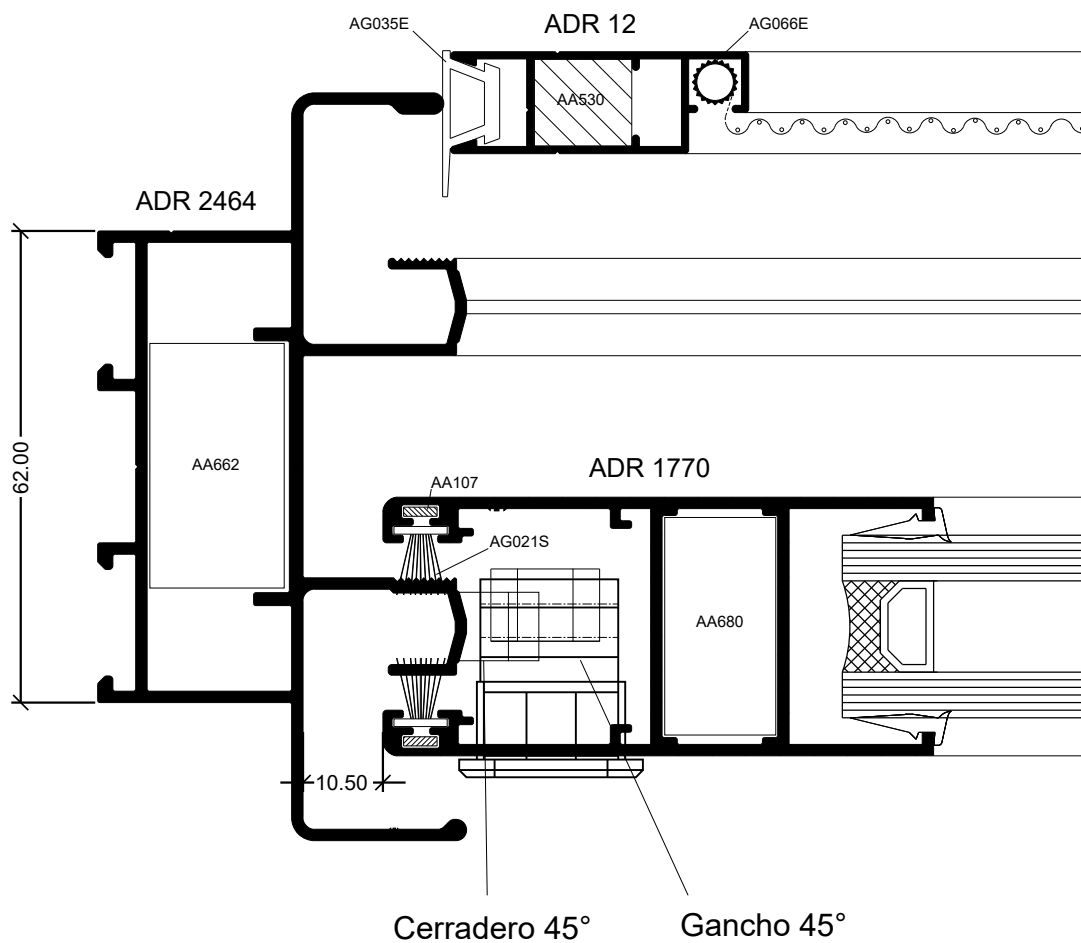

HA62 CORREDIZA



La Aldaba® Hydro

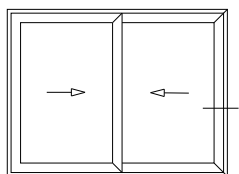

H56 DOPPIO - H101

Lateral Corrediza 2 hojas
Marco a 45° / Hoja a 90°

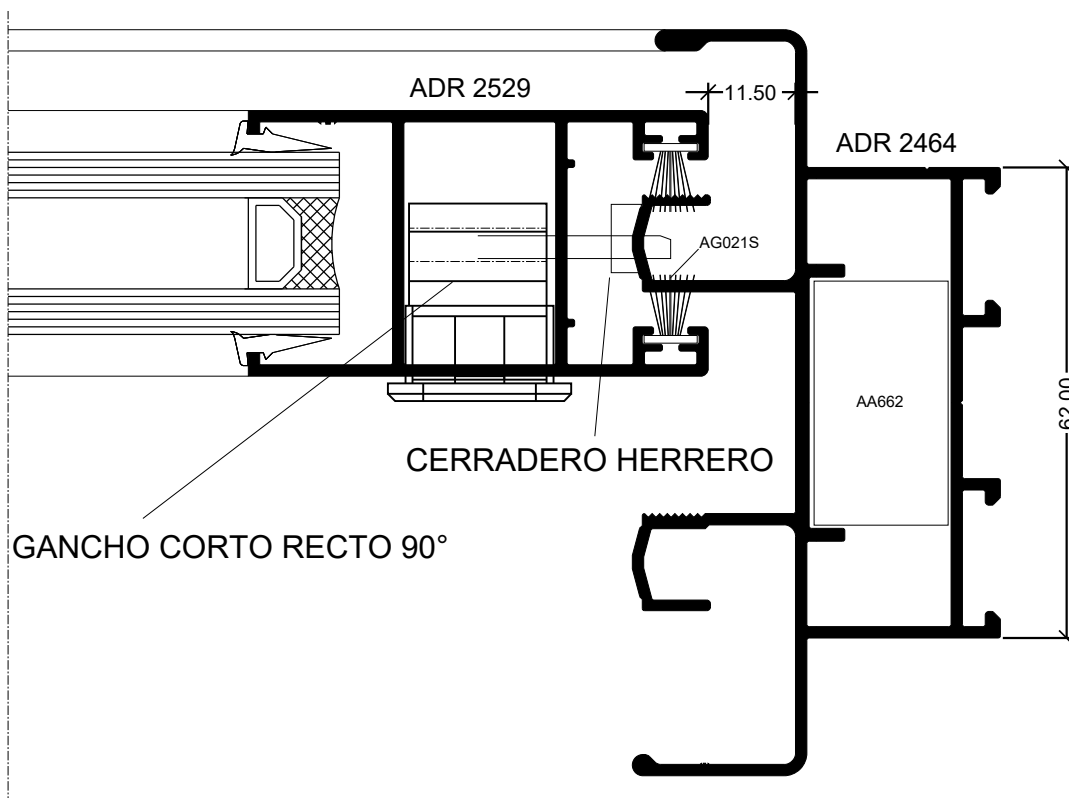

HA62 CORREDIZA

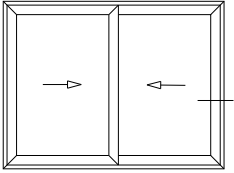

H56 DOPPIO - H101

Lateral Corrediza 2 hojas
Marco a 90° / Hoja a 90°

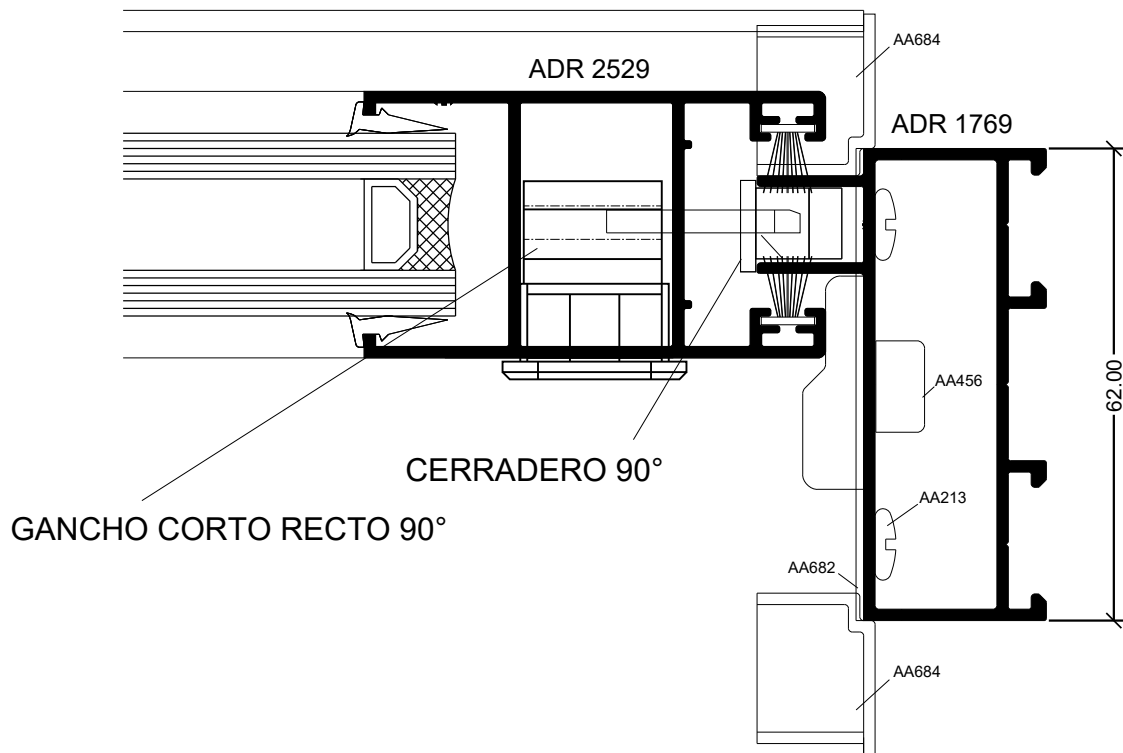

NÓRDICAL

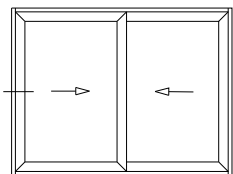

PROiN

La Aldaba

Hydro

H56 DOPPIO - H101

Lateral Corrediza 2 hojas
Marco a 90° / Hoja a 45°

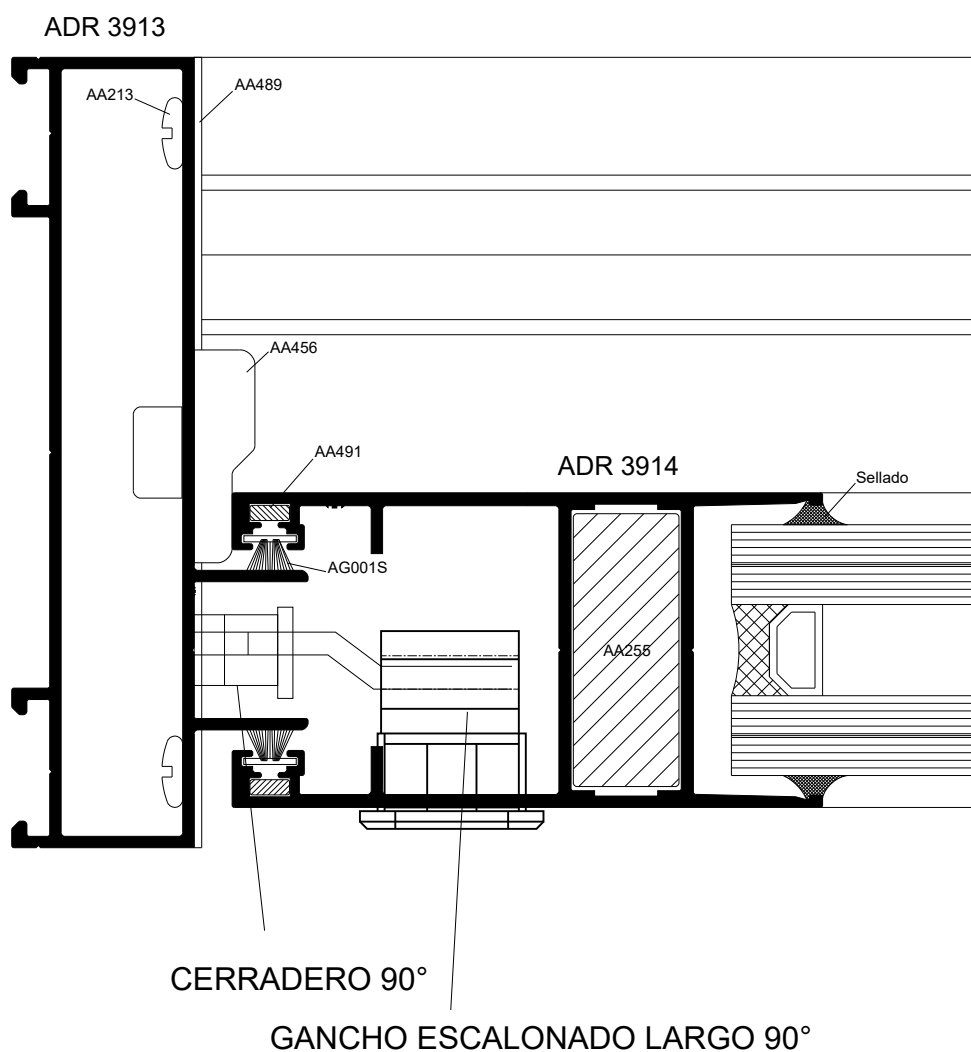

NÓRDICAL

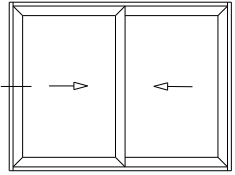

Lateral Izquierdo Corrediza 2 Hojas a 90°

H56 DOPPIO - H101

Lateral Corrediza 2 hojas
Marco a 90° / Hoja a 90°

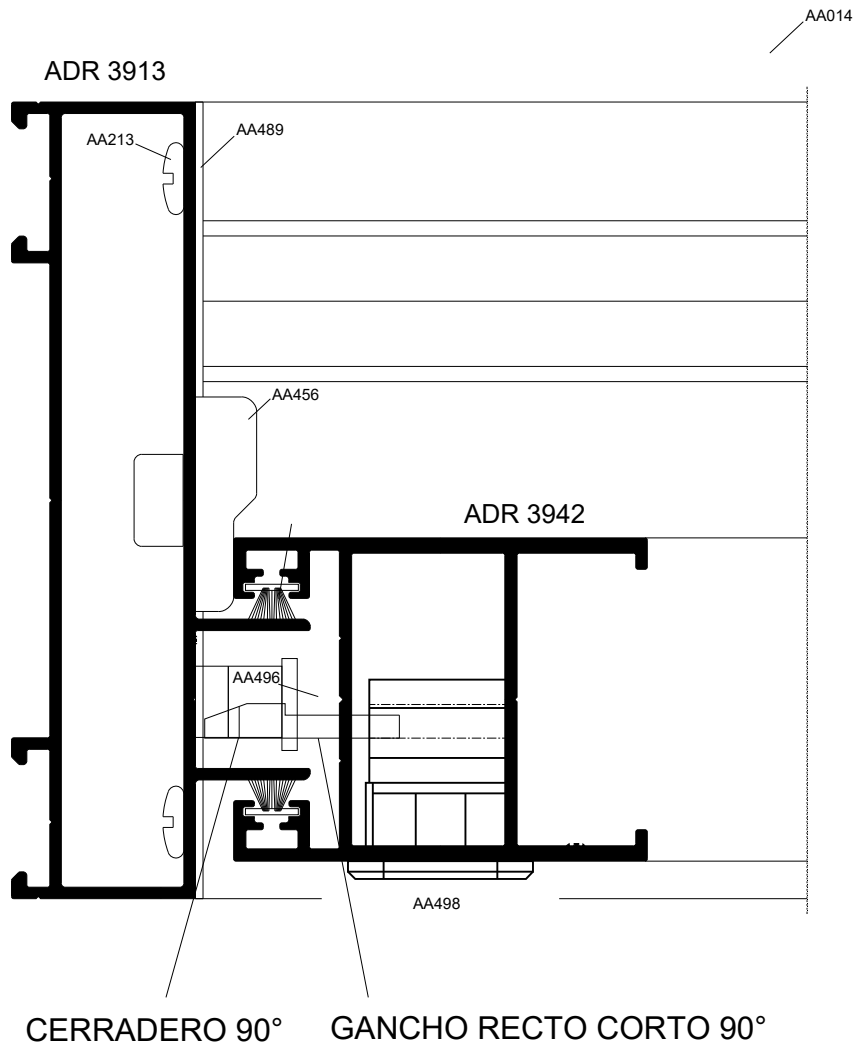

ORBITAL

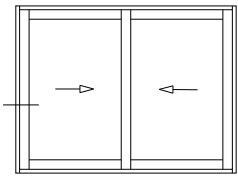

H56 DOPPIO - H101

Lateral Corrediza 2 hojas + mosquitero

Marco a 90° / Hoja a 90°

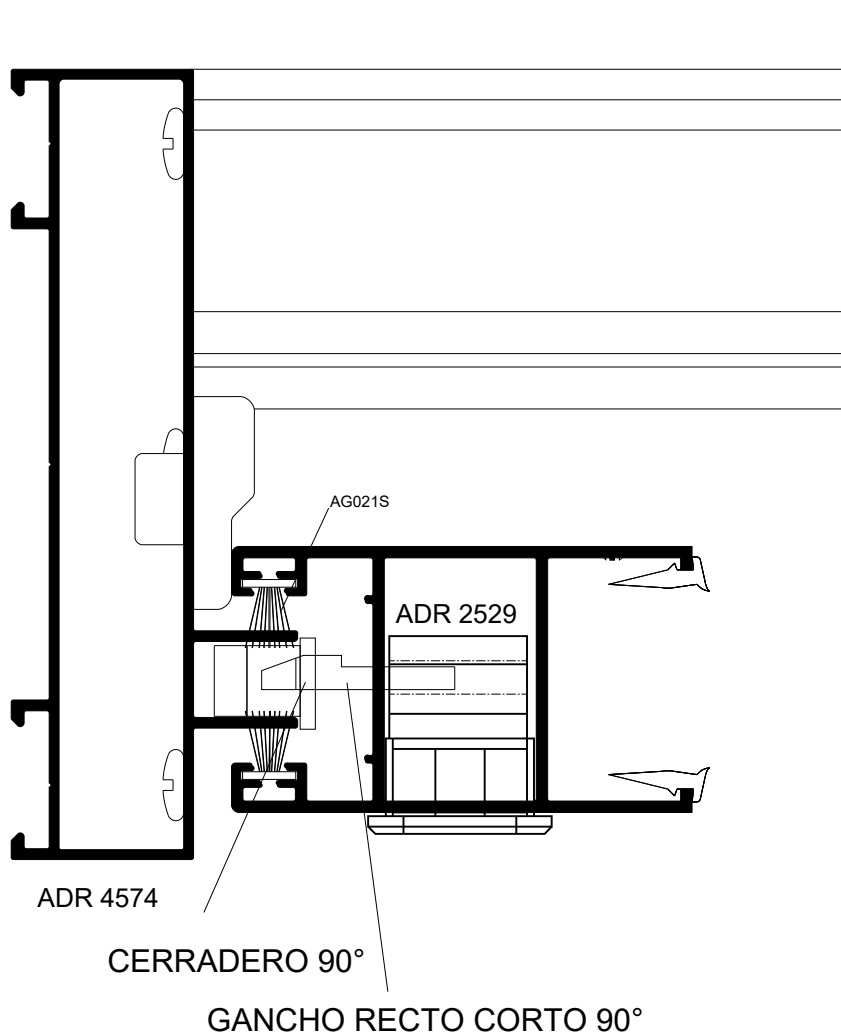

ORBITAL

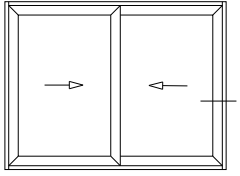

H56 DOPPIO - H101

Lateral Corrediza 2 hojas + mosquitero

Marco a 90° / Hoja a 45°

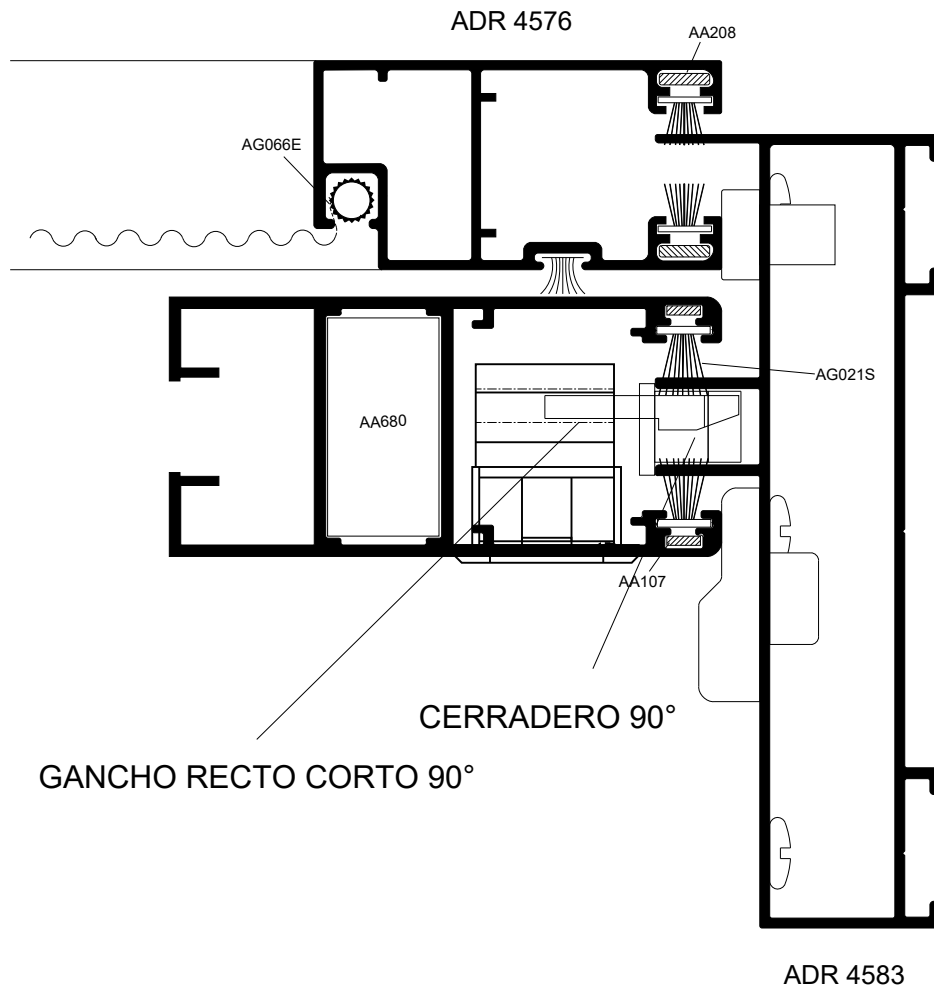

ORBITAL

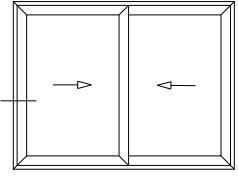

PROiN



La Aldaba



Hydro

H56 DOPPIO - H101

Lateral Corrediza 2 hojas + mosquitero

Marco a 45° / Hoja 45°

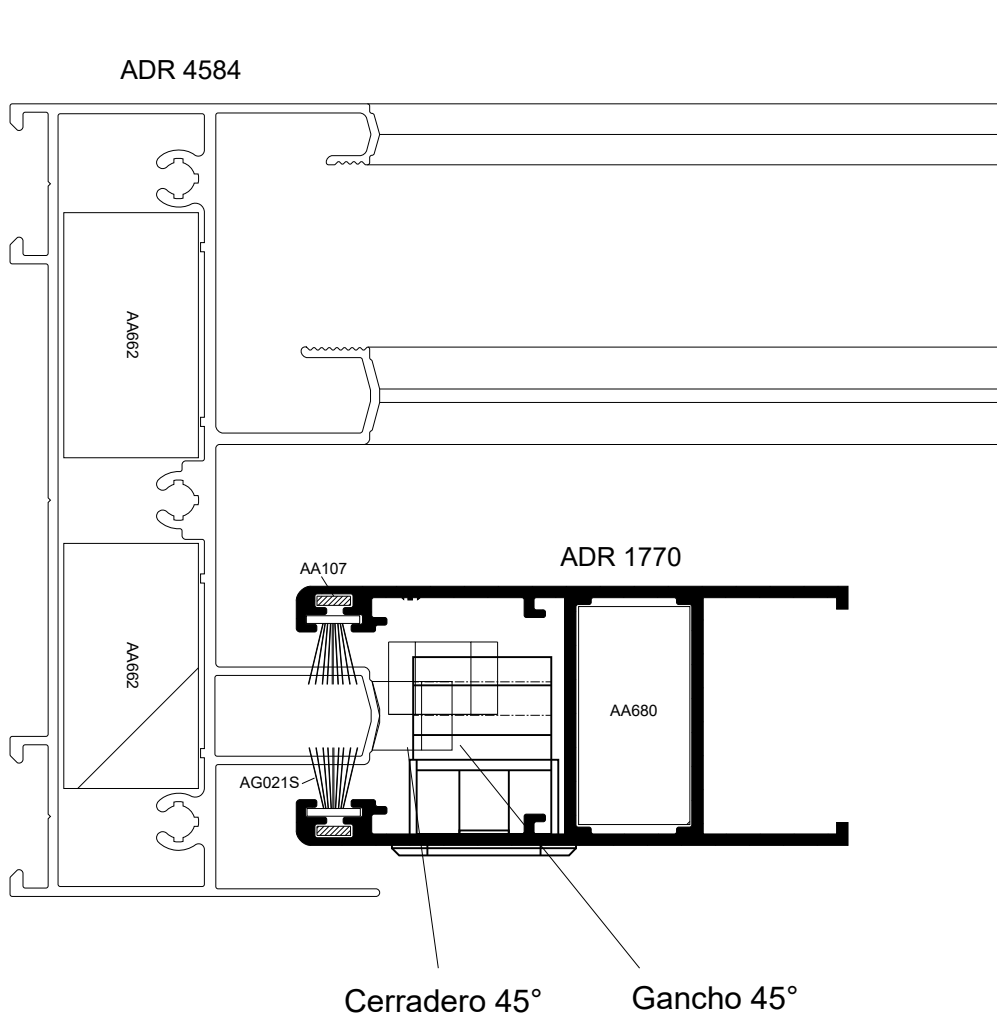

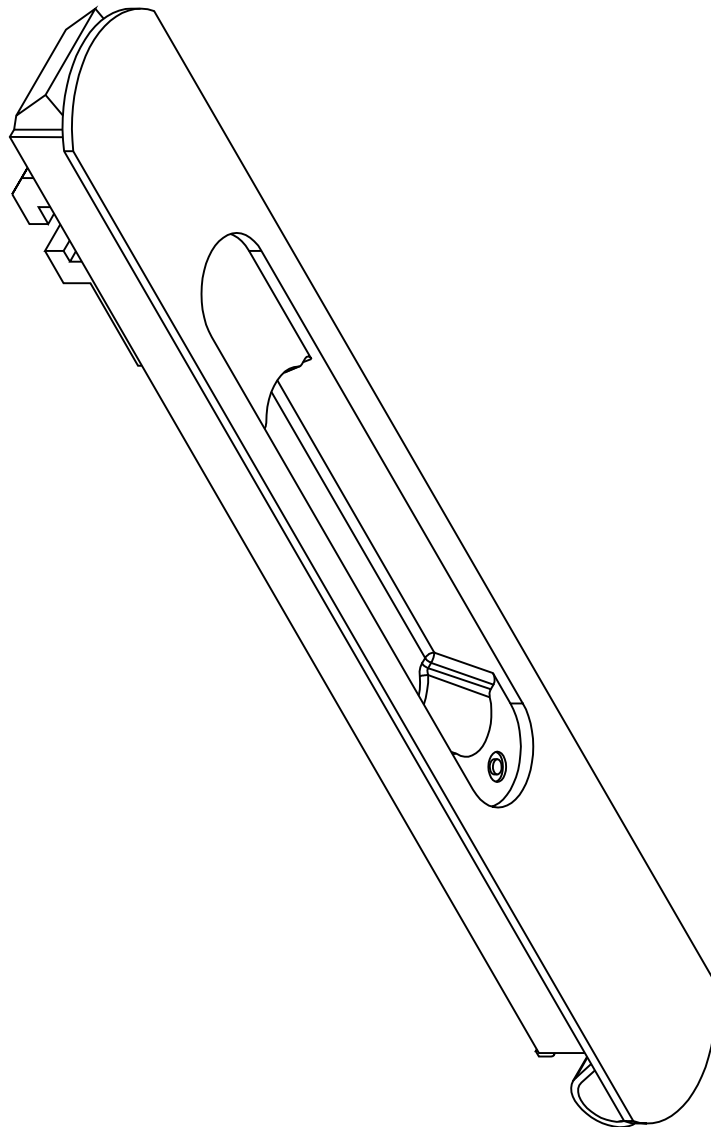

H56 ESTILO PROIN
Escala 1:1

HA62 CORREDIZA

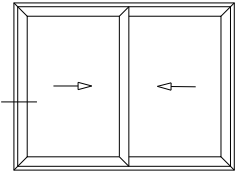

H56 ESTILO PROIN

Lateral Corrediza 2 hojas
Marco a 45° / Hoja a 45°

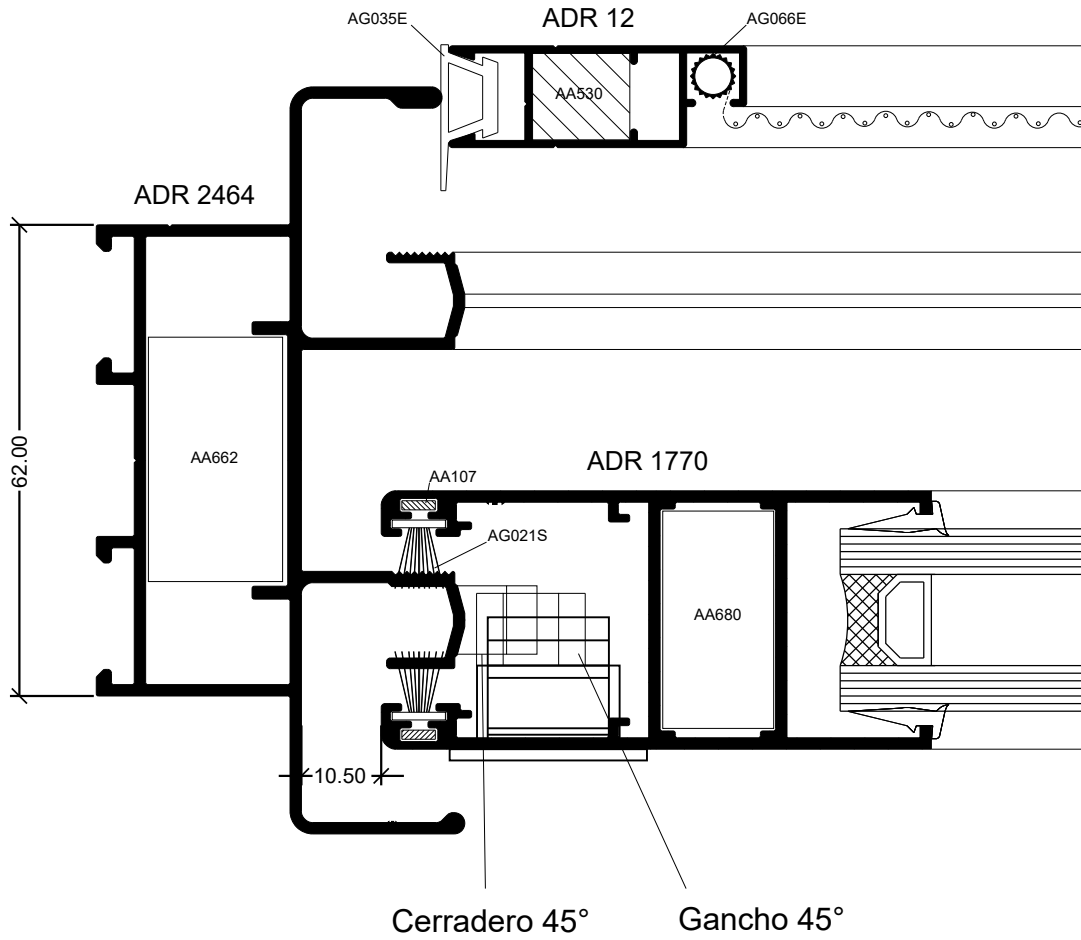

HA62 CORREDIZA

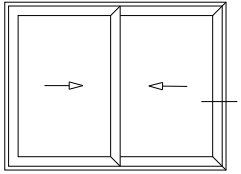

H56 ESTILO PROIN

Lateral Corrediza 2 hojas
Marco a 45° / Hoja a 90°

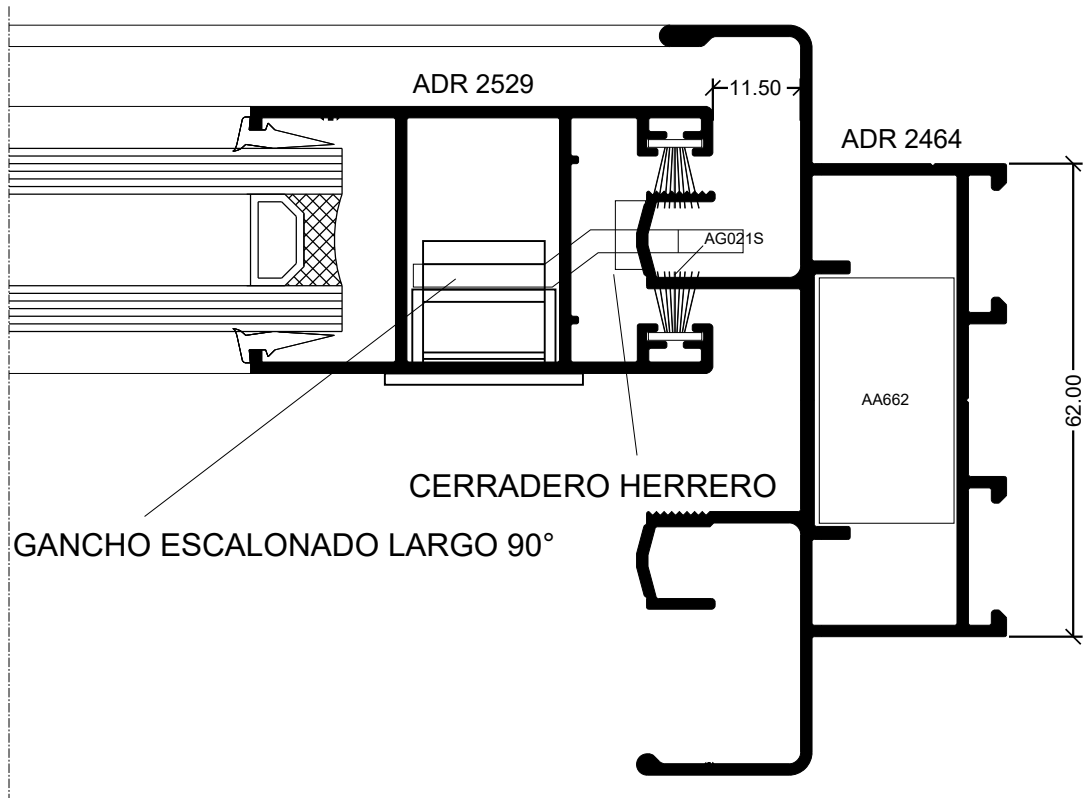

HA62 CORREDIZA

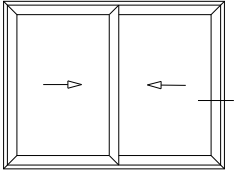

H56 ESTILO PROIN

Lateral Corrediza 2 hojas
Marco a 90° / Hoja a 90°

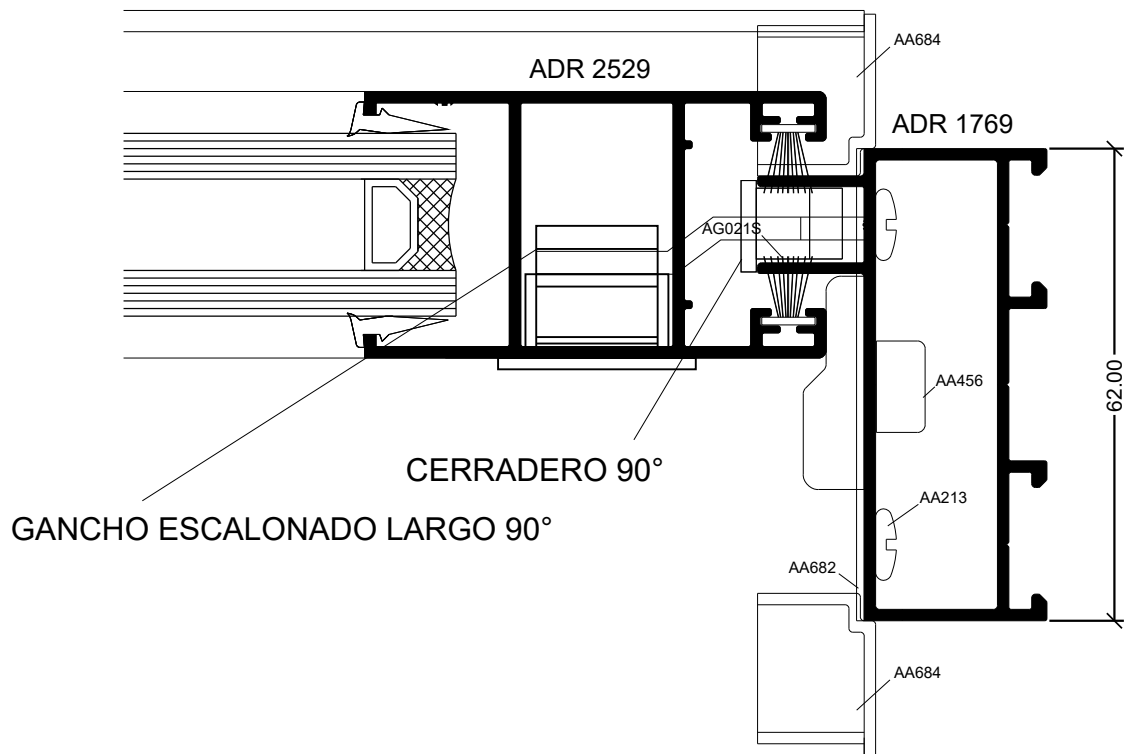

NÓRDICAL

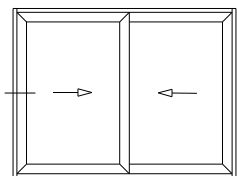

PROiN

La Aldaba

Hydro

H56 ESTILO PROIN

Lateral Corrediza 2 hojas
Marco a 90° / Hoja a 45°

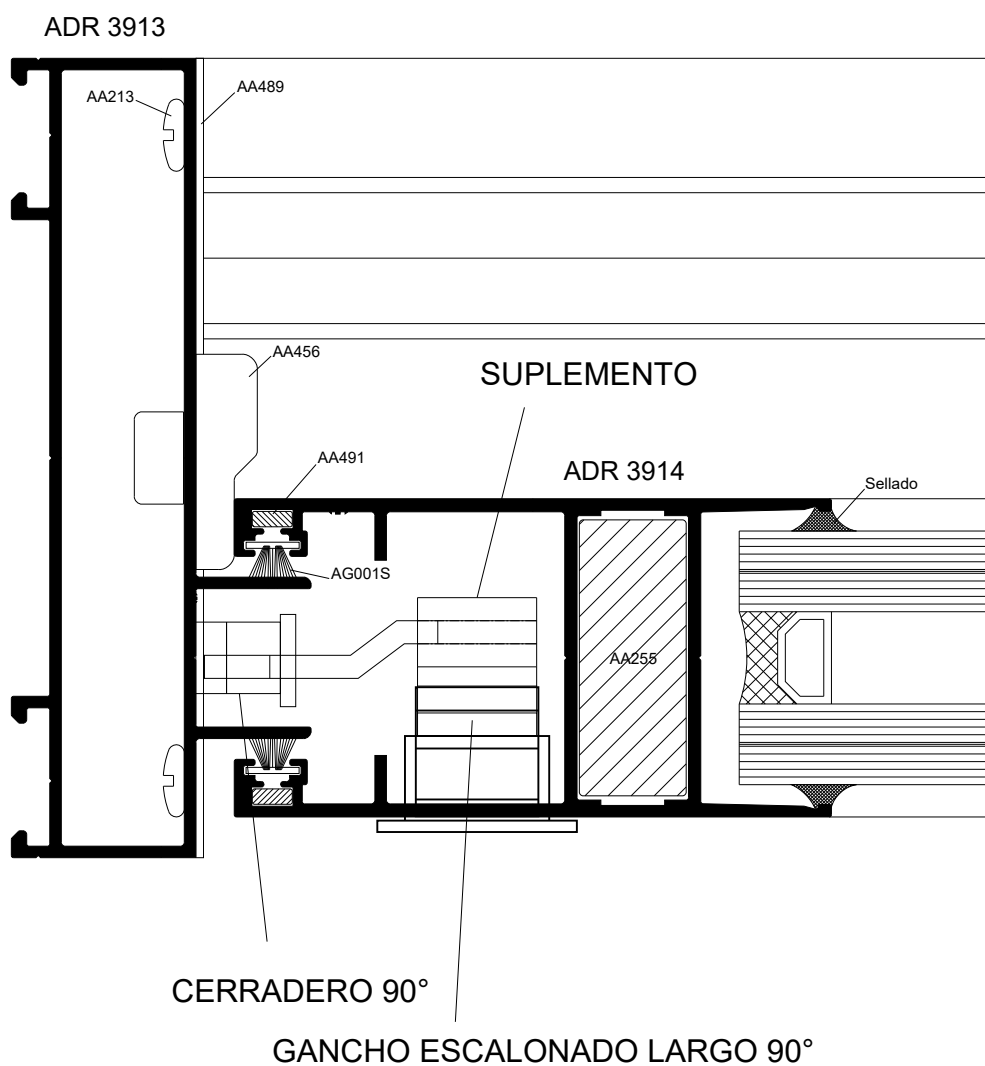

NÓRDICAL

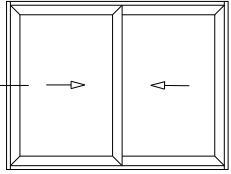

Lateral Izquierdo Corrediza 2 Hojas a 90°

H56 ESTILO PROIN

Lateral Corrediza 2 hojas
Marco a 90° / Hoja a 90°

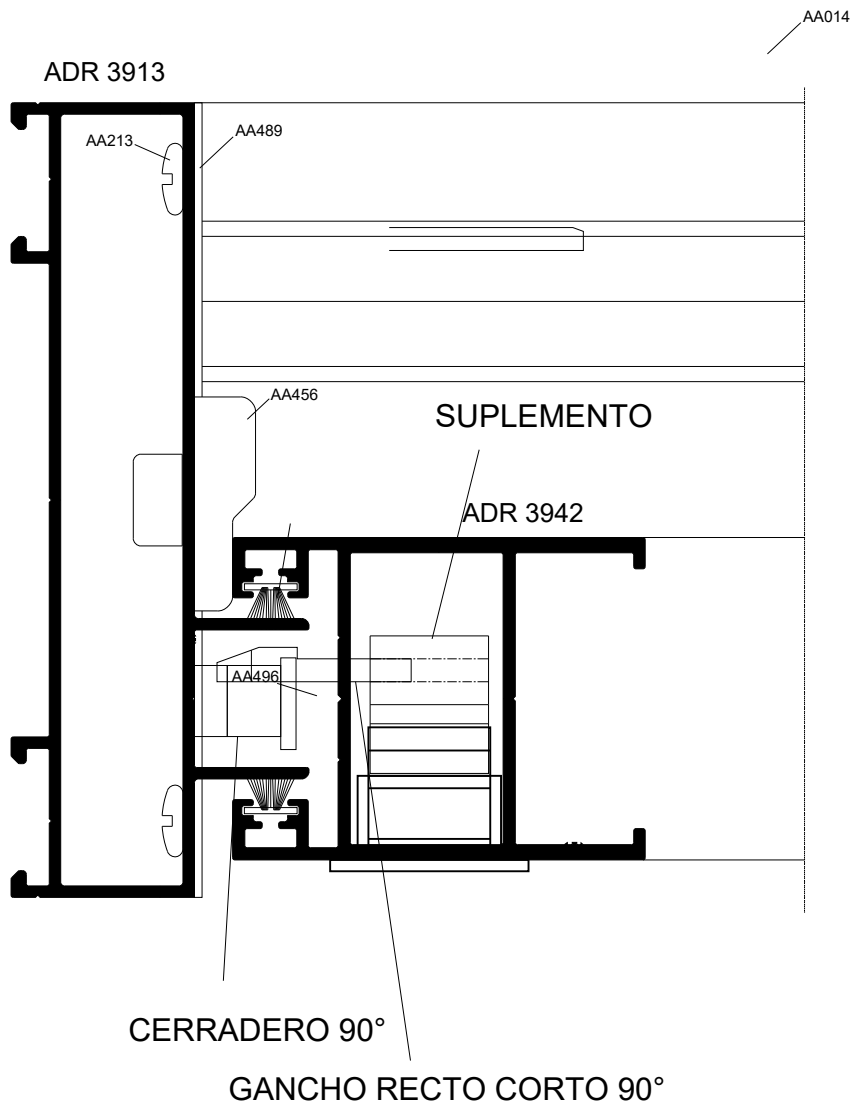

ORBITAL

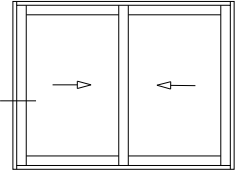

PROiN



La Aldaba



Hydro

H56 ESTILO PROIN

Lateral Corrediza 2 hojas + mosquitero

Marco a 90° / Hoja a 90°

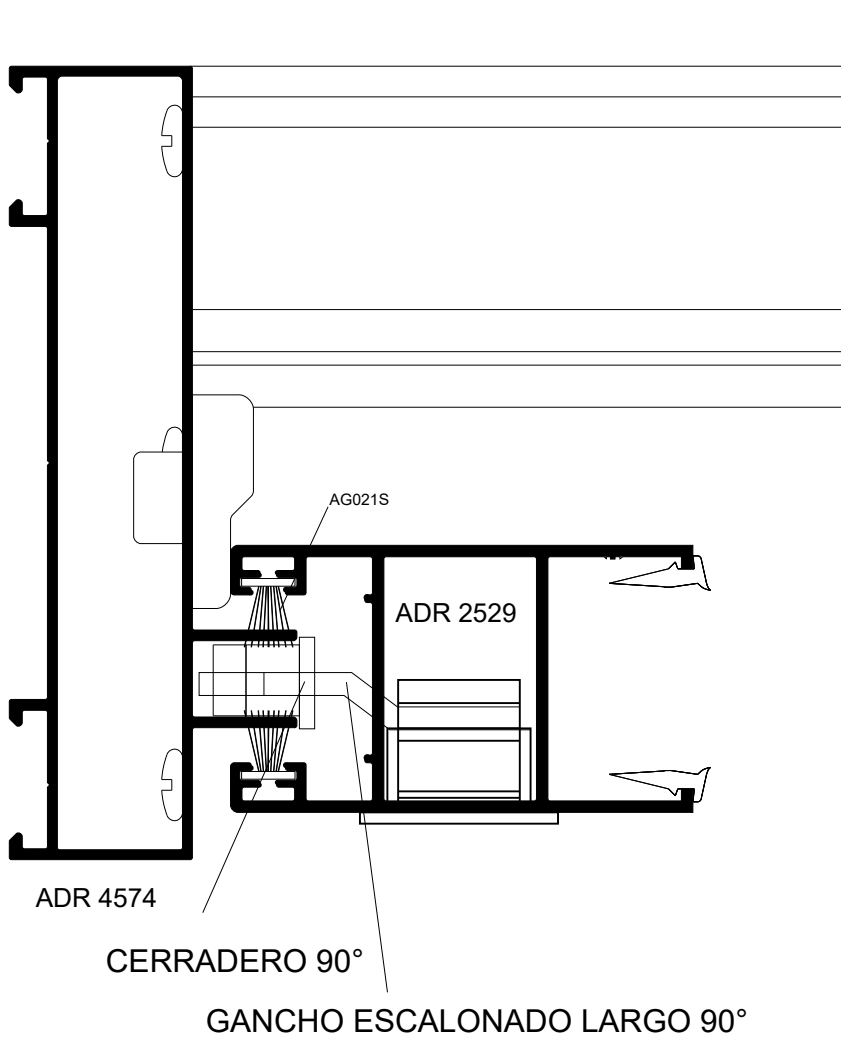

ORBITAL

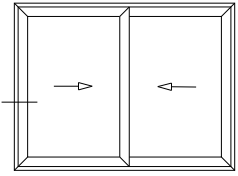

H56 ESTILO PROIN

Lateral Corrediza 2 hojas + mosquitero

Marco a 45° / Hoja 45°

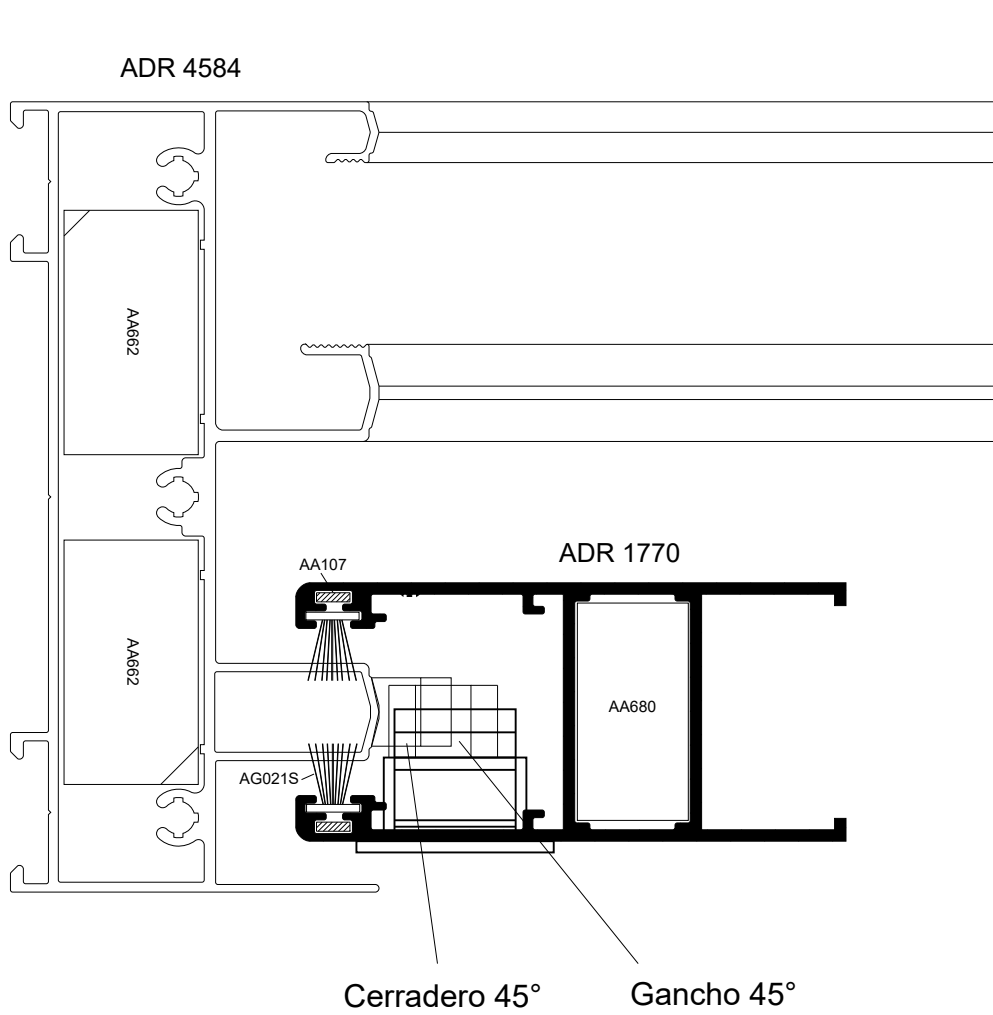

2200

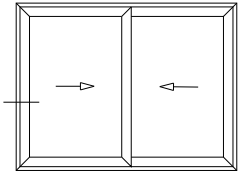

H56 ESTILO PROIN

Lateral Corrediza 2 hojas + mosquitero

Marco a 90° / Hoja 90°

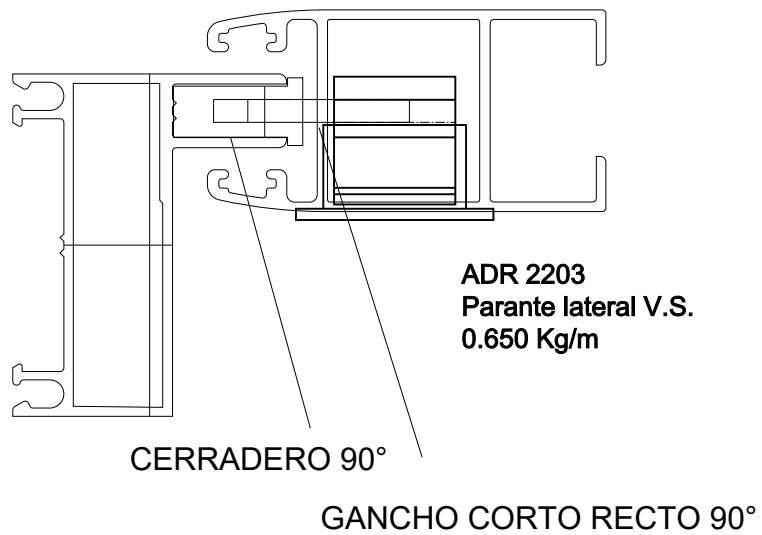

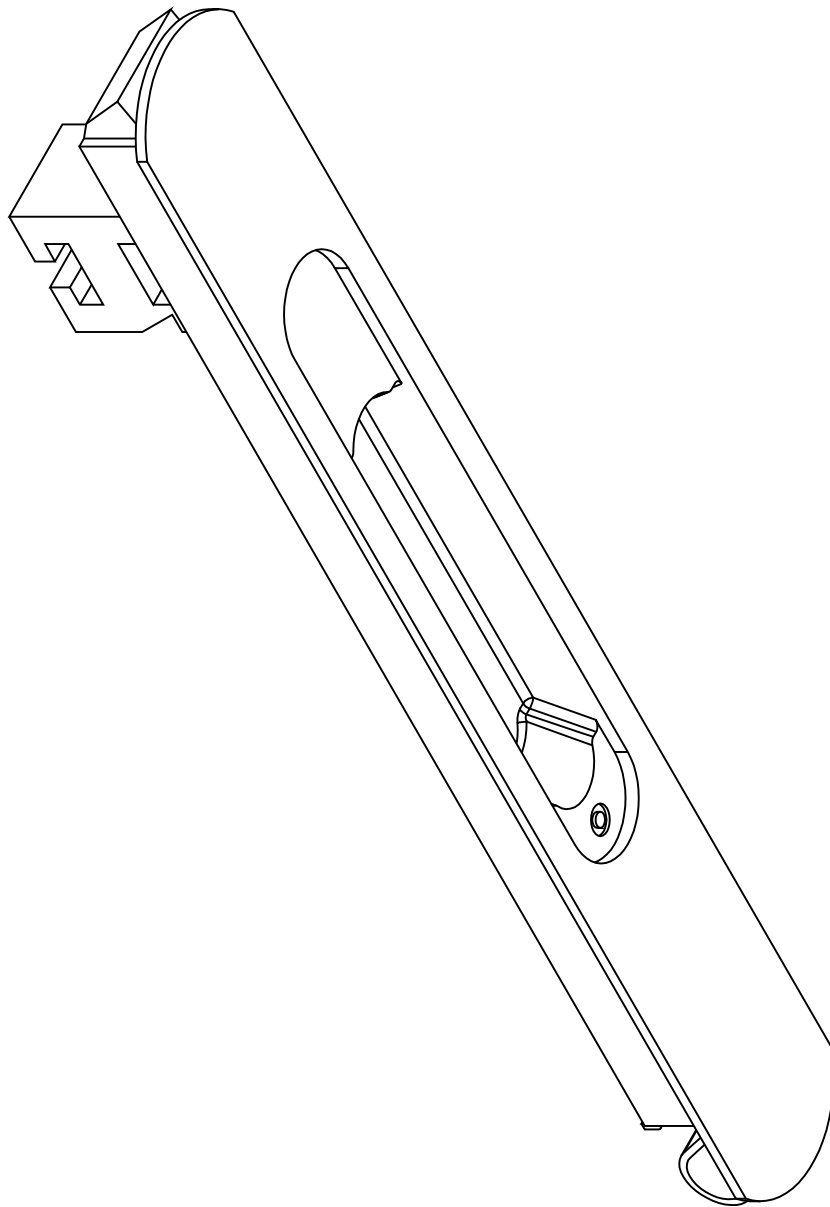

H56-H101 ESTILO PROiN
Escala 1:1

HA62 CORREDIZA

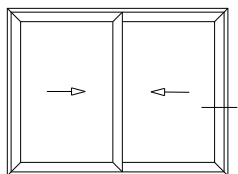

H56-H101 ESTILO PROIN

Lateral Corrediza 2 hojas
Marco a 90° / Hoja a 90°

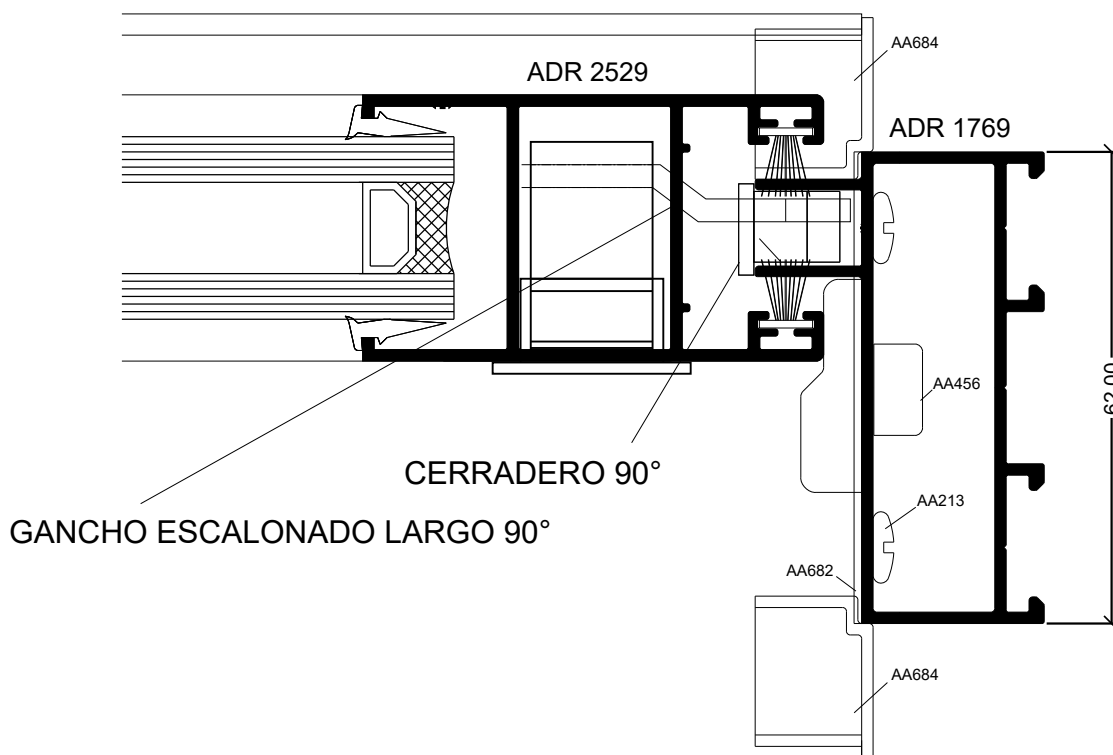

NÓRDICAL

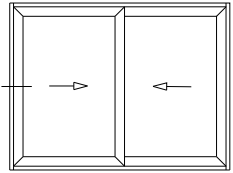

PROiN

La Aldaba

Hydro

H56-H101 ESTILO PROIN

Lateral Corrediza 2 hojas
Marco a 90° / Hoja a 45°

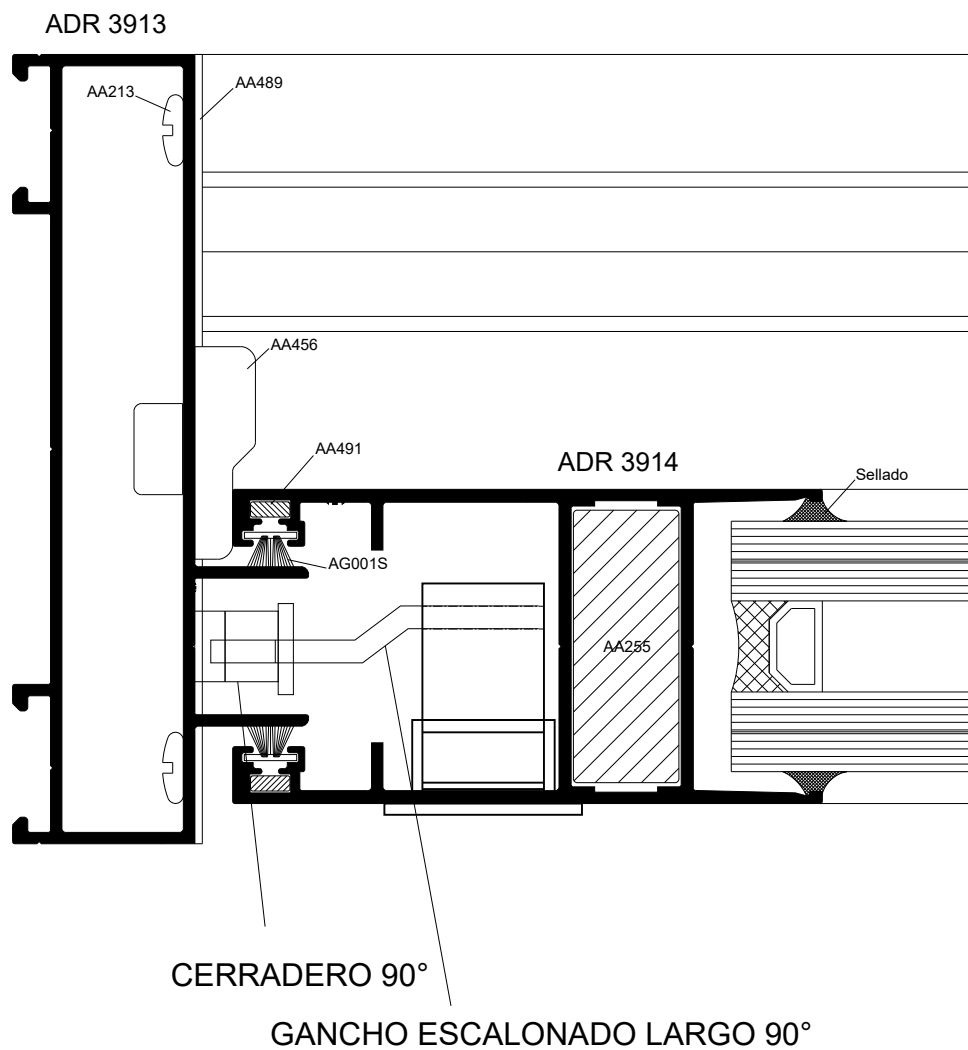

NÓRDICAL

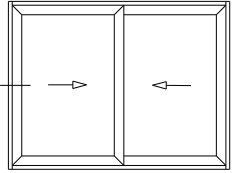

Lateral Izquierdo Corrediza 2 Hojas a 90°

H56-H101 ESTILO PROIN

Lateral Corrediza 2 hojas
Marco a 90° / Hoja a 90°

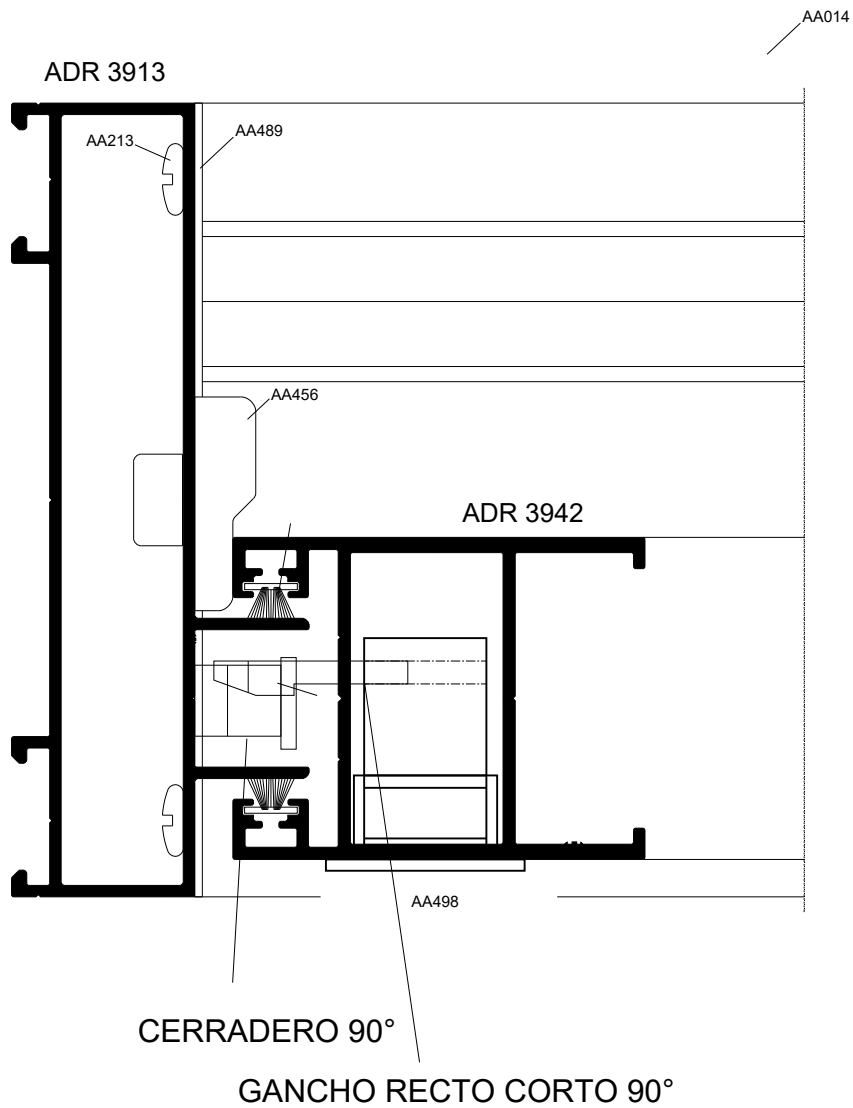

ORBITAL

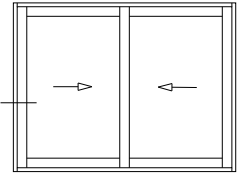

PROiN



La Aldaba



Hydro

H56-H101 ESTILO PROIN

Lateral Corrediza 2 hojas
Marco a 90° / Hoja a 90°

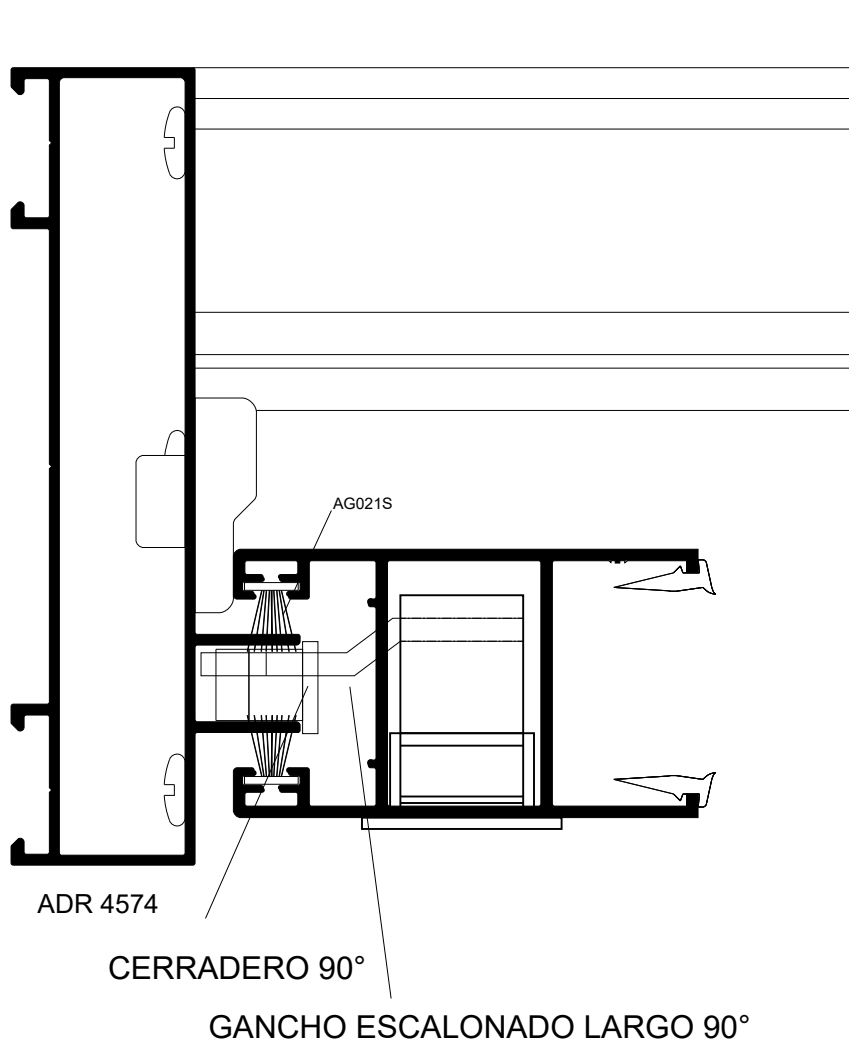

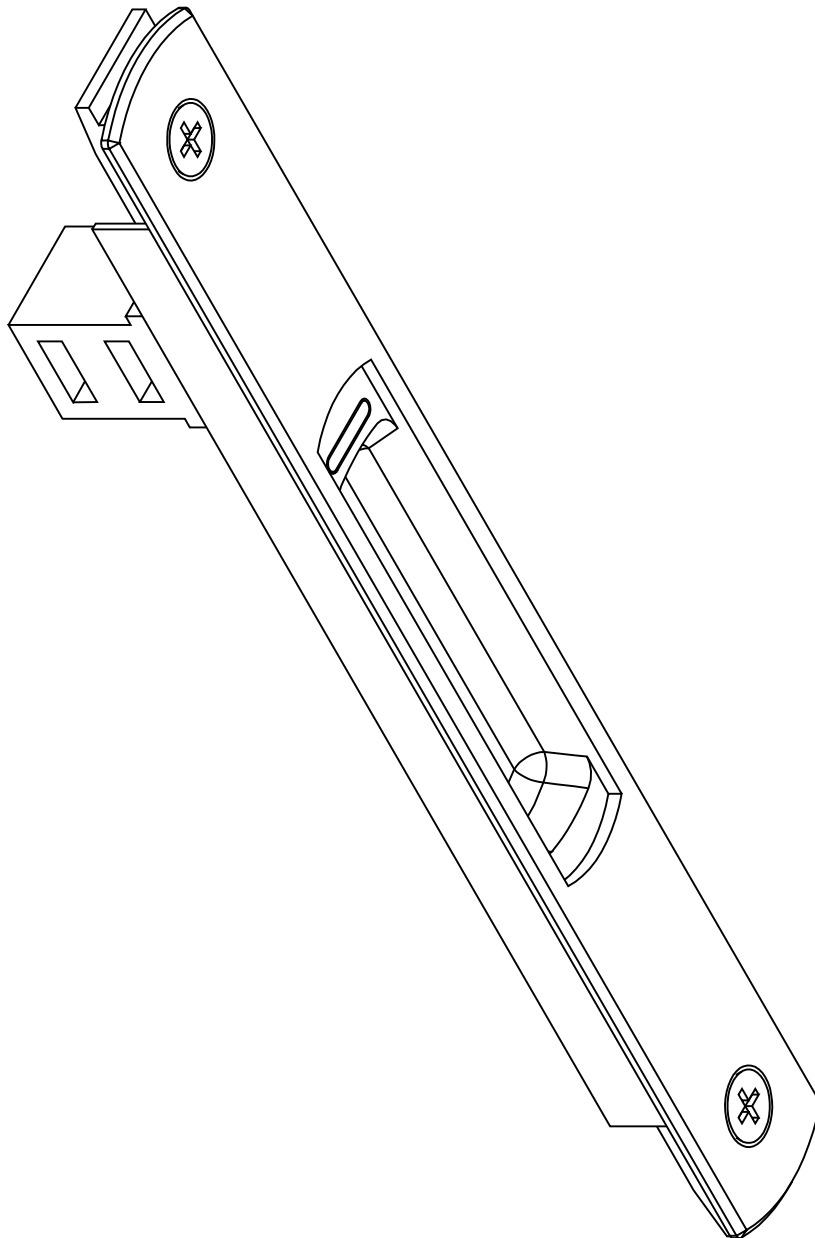

H101-1501 PROIN
Escala 1:1

HA62 CORREDIZA

PROiN

La Aldaba

Hydro

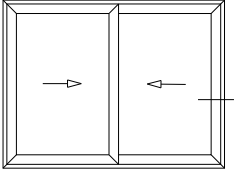

H54 PROIN ALUMINIO

Lateral Corrediza 2 hojas
Marco a 90° / Hoja a 90°

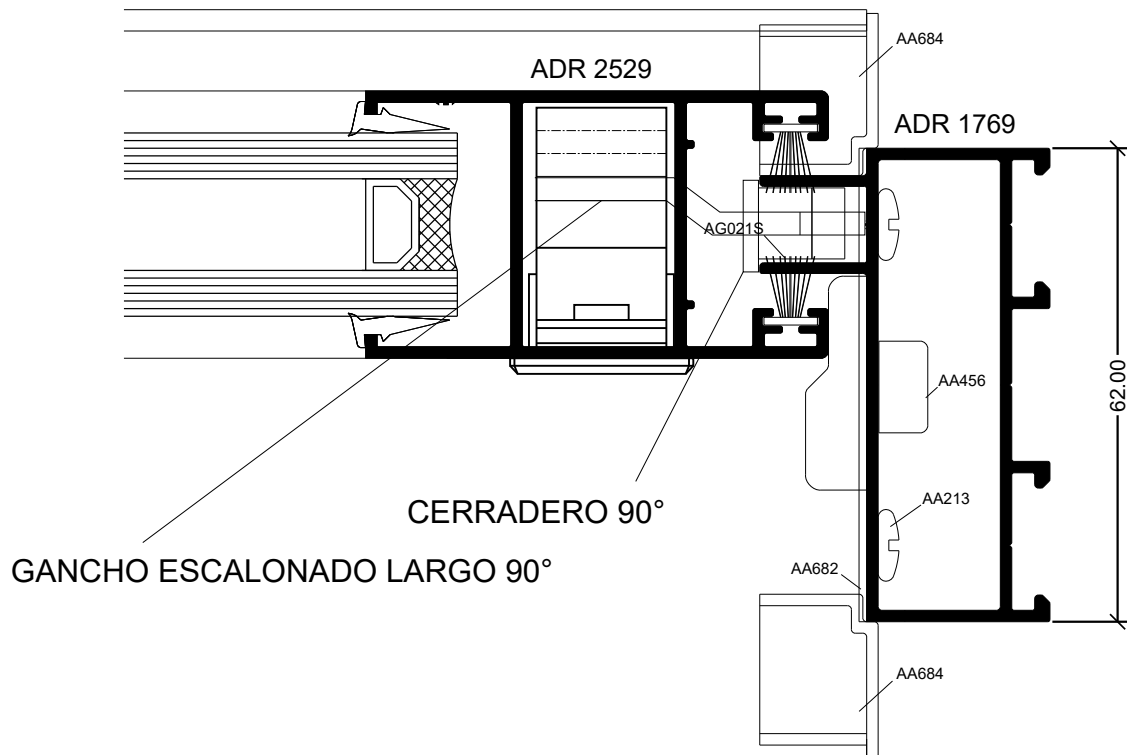

NÓRDICAL

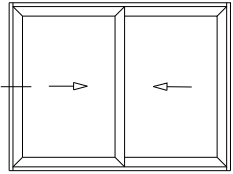

PROiN



La Aldaba



Hydro

H101-1501 PROIN

Lateral Corrediza 2 hojas
Marco a 90° / Hoja a 45°

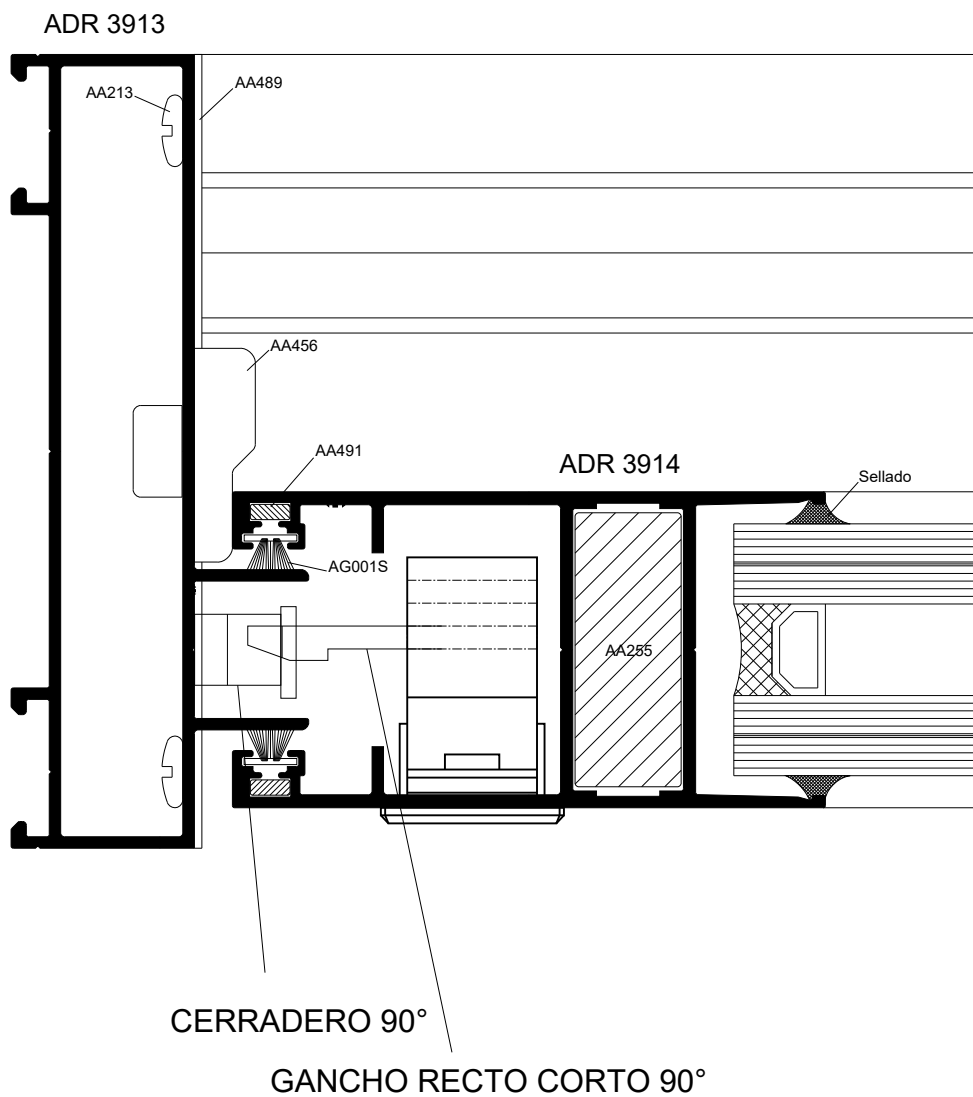

NÓRDICAL

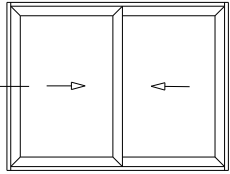

Lateral Izquierdo Corrediza 2 Hojas a 90°

H54 PROIN ALUMINIO

Lateral Corrediza 2 hojas
Marco a 90° / Hoja a 90°

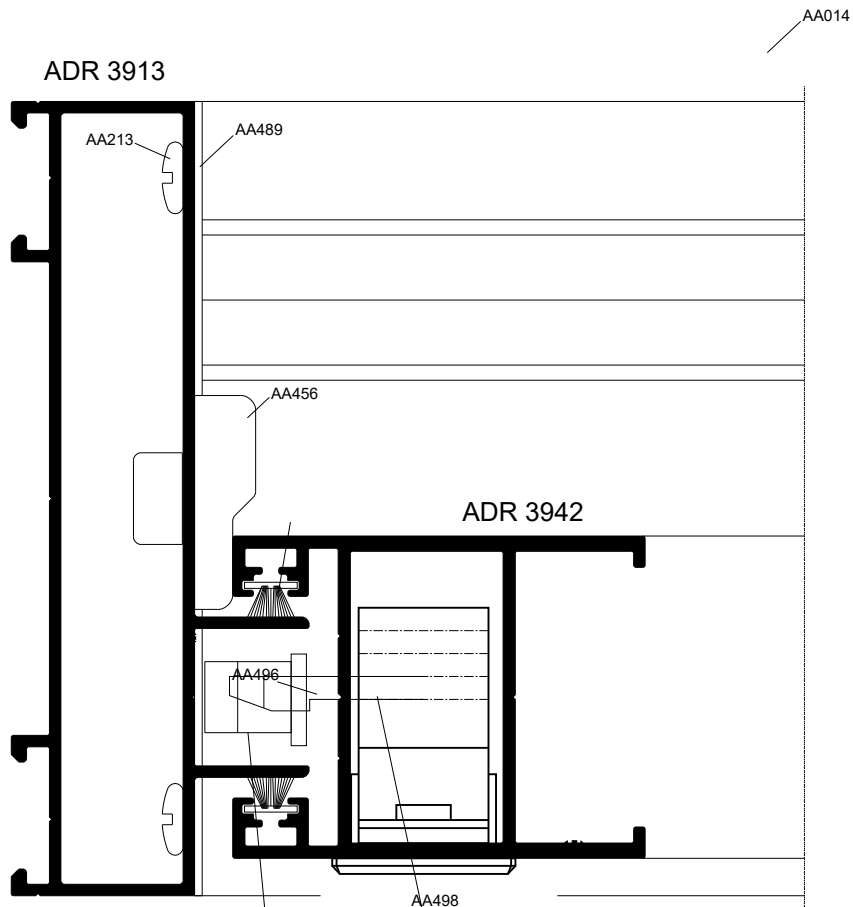

CERRADERO 90°

GANCHO RECTO CORTO 90°

ORBITAL

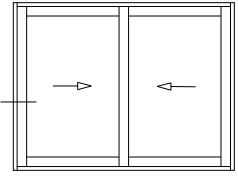

Lateral Corrediza 2 hojas + mosquitero

Marco a 90° / Hoja a 90°

